

**iExaminer®
Assembly
instructions**

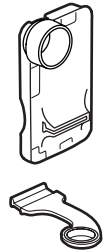

+

11810 / 11820

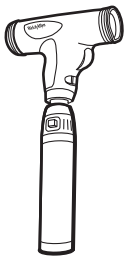

1

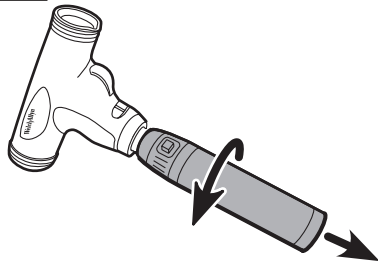

2

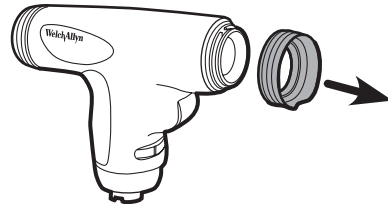

3

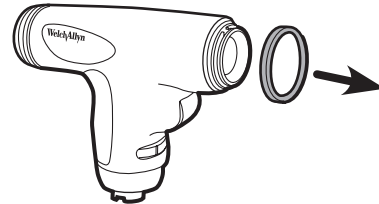

4

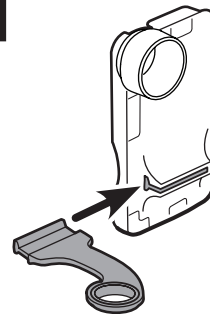

5

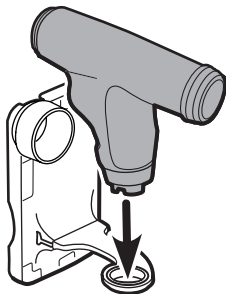

6

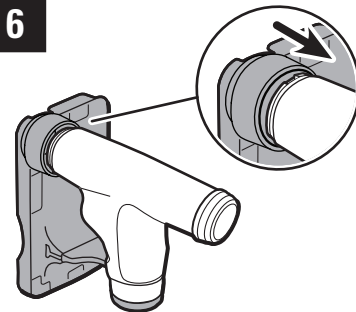

7

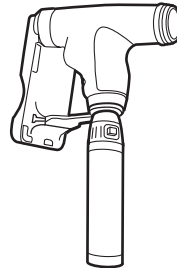
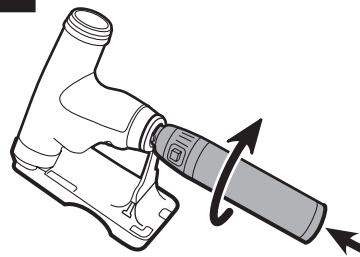

www.welchallyn.com/iExaminer

Welch Allyn Technical Support
www.welchallyn.com/support
www.welchallyn.com/about/company/locations.htm

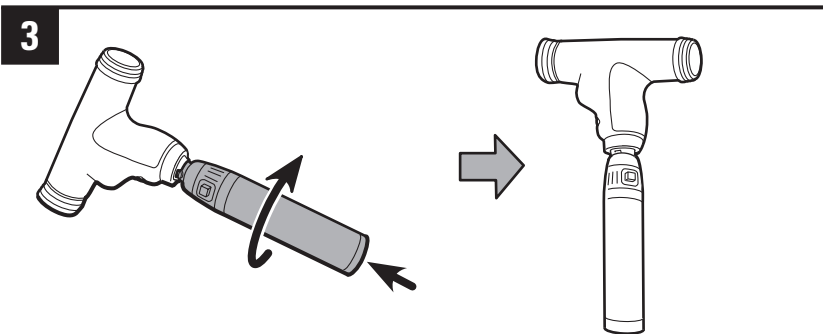
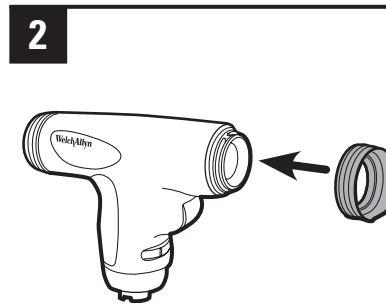
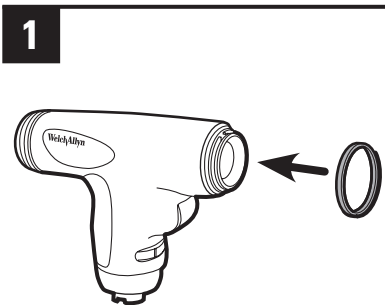
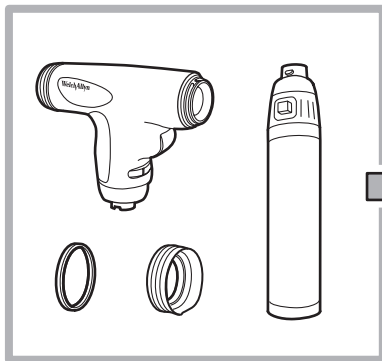

Manufacturer
Welch Allyn, Inc.
4341 State Street Road
Skaneateles Falls, NY 13153 USA
www.welchallyn.com

EC REP
Regulatory Affairs Representative, EU
Welch Allyn Limited
Navan Business Park
Dublin Road
Navan, County Meath
Republic of Ireland

iExaminer is a registered trademark of
Intuitive Medical Technologies, LLC.

Consult PanOptic
Instructions for use

WelchAllyn®

iExaminer®
Assembly instructions
for mobile devices

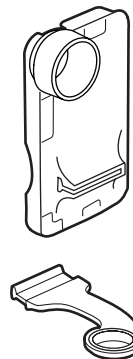

R_x ONLY

Mat. 723860, 80020729 Ver. A
© 2015 Welch Allyn, Inc.
Revision date: 2015-11