

# Welch Allyn Connectivity Server

---

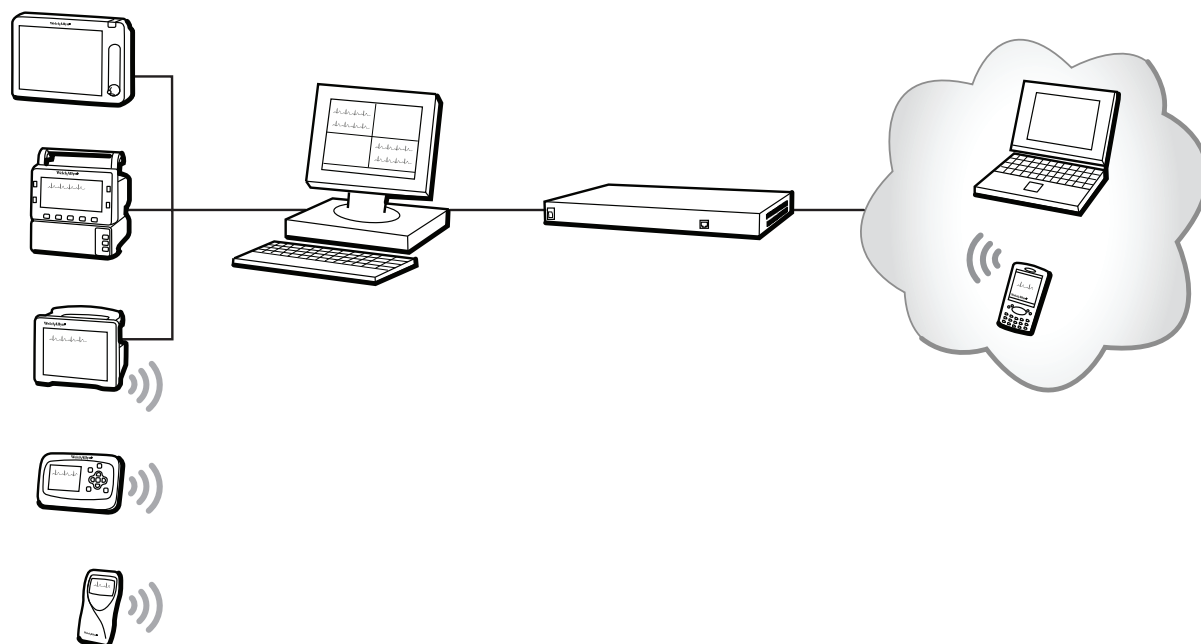

---

## Programmer's guide

Software version 2.6x

**WelchAllyn**<sup>®</sup>

Advancing Frontline Care<sup>™</sup>

© 2013 Welch Allyn. All rights are reserved. To support the intended use of the product described in this publication, the purchaser of the product is permitted to copy this publication, for internal distribution only, from the media provided by Welch Allyn. No other use, reproduction, or distribution of this publication, or any part of it, is permitted without written permission from Welch Allyn.

Welch Allyn assumes no responsibility for any injury to anyone, or for any illegal or improper use of the product, that may result from failure to use this product in accordance with the instructions, cautions, warnings, or statement of intended use published in this manual.

Welch Allyn, Acuity, AcuityLink, Propaq, Micropaq are registered trademarks of Welch Allyn. Sun, Solaris and Java are registered trademarks of Sun Microsystems, Inc. Emergin is a registered trademark of Emergin, Inc.

For patent information, please visit [www.welchallyn.com/patents](http://www.welchallyn.com/patents).

Software in this product is copyright Welch Allyn or its vendors. All rights are reserved. The software is protected by United States of America copyright laws and international treaty provisions applicable worldwide. Under such laws, the licensee is entitled to use the copy of the software incorporated with this instrument as intended in the operation of the product in which it is embedded. The software may not be copied, decompiled, reverse-engineered, disassembled or otherwise reduced to human-perceivable form. This is not a sale of the software or any copy of the software; all right, title and ownership of the software remain with Welch Allyn or its vendors.

For information about any Welch Allyn product, visit [www.welchallyn.com/about/company/locations.htm](http://www.welchallyn.com/about/company/locations.htm).

Manual 80018556 Ver A



Welch Allyn Protocol, Inc.  
8500 SW Creekside Place  
Beaverton, Oregon 97008-7101 USA

EC REP

Regulatory Affairs Representative  
Welch Allyn Limited  
Navan Business Park  
Dublin Road, Navan  
County Meath, Republic of Ireland

[www.welchallyn.com](http://www.welchallyn.com)

**WelchAllyn®**

# Contents

---

<b>1 - Introduction</b> .....	<b>1</b>
Intended use .....	1
Conventions .....	2
Warning and note .....	2
Related documents .....	3
<b>2 - System overview</b> .....	<b>5</b>
Welcome! .....	5
Data interface provided by the Welch Allyn Connectivity Server (WACS) .....	6
Data transfer and storage within the Acuity System network .....	7
<b>3 - HL7 standard protocols</b> .....	<b>11</b>
Health Level Seven Standard .....	11
HL7 low-level protocol .....	12
HL7 segment-level protocols .....	12
<b>4 - WACS outbound HL7 protocols</b> .....	<b>15</b>
Overview: Outbound HL7 Vital-sign Observations module .....	16
Labels and attributes of outbound segments .....	17
Outbound patient identification fields .....	21
Outbound vital-sign tags and filters .....	22
Reconfiguring WACS outbound observation settings .....	24
<b>5 - WACS outbound HL7 messages</b> .....	<b>27</b>
Unsolicited observation message	
ORU^R01/ACK^R01 .....	28
Query for results of observation message	
QRY^R02/ORF^R04 .....	30
Query by parameter	
QBP^Q11/RSP^Z90 .....	33
Query by ID .....	36
Query by location .....	38
<b>6 - Inbound ADT HL7 messages</b> .....	<b>41</b>
Overview: Inbound HL7 ADT Data module .....	42
How an Acuity System uses ADT information .....	43
ADT messages accepted and stored by WACS .....	46
Examples of ADT messages .....	52
Reconfiguration of ADT services .....	54

<b>7 - XML interface</b> .....	<b>55</b>
<b>8 - Contacts and specifications</b> .....	<b>57</b>
Contact information .....	57
Specifications .....	57

## 1

# Introduction

---

## Intended use

The Welch Allyn Connectivity Server (WACS) is an option to the Welch Allyn Acuity® Central Monitoring System. WACS consists of a server platform on which one or more of the following software options are installed:

- The Web Server option makes Adobe® Portable Document Format (PDF) printout files available from the Acuity System to certain Web browsers.
- The AcuityLink® option consists of Clinician Notifier software for non-proprietary mobile devices and administrative software for WACS. Mobile devices running the Clinician Notifier software deliver patient alarm information and realtime waveforms gathered from patient monitors connected to the Acuity Central Monitoring System.

The software enables administrators to track the status of clinician-patient assignments, and it enables clinicians to track, respond to and view Acuity System patient alarms, view realtime patient waveforms and view historical alarm details and waveforms.

- The HL7 Interface options support the following features using HL7 messaging protocol: export of vital-signs data from the Acuity Central Monitoring System to hospital CIS/HIS systems, and import of ADT data from hospital clinical information systems/hospital information systems (CIS/HIS) to the Acuity System.
- The WACS Barcode Scanner option allows clinicians to enter patient IDs and room numbers into the Acuity System using barcode scanners on some mobile devices running Clinician Notifier software.
- The Third Party Data Stream Interface option supports sending patient alarms and equipment alerts in XML format to third party interfaces.

WACS is to be used by authorized health care professionals using standard institutional procedures and good clinical practice guidelines for patient monitoring. Staff training in the operation of WACS is essential for optimal use. Users should be skilled at the level of clinicians, clinical administrators and hospital administrators, with the knowledge and experience to acquire and interpret patients' vital signs. Each of these roles is assigned and associated with specific privileges and scopes. Access privileges are controlled through passwords.

Individuals using WACS should be familiar with its operation as described in this manual, and they should understand all warnings and cautions in the manual.

## Conventions



The CE Mark and Notified Body Registration Number signify that the product meets all essential requirements of European Medical Device Directive 93/42/EEC.

---



**WARNING** Indicates conditions or practices that could lead to illness, injury, or death.

## Warning and note



**WARNING** HL7 configuration must be performed only by qualified personnel who are familiar with the HL7 Standard and with local implementation of the WACS HL7 Interface. Improper configuration of the HL7 Interface can cause unexpected and unintended cessation of patient vital-signs data transfer.

**Note** In compliance with the U.S. Department of Health and Human Services Health Insurance Portability and Accountability Act (HIPAA), do not transfer or save patient data or information using any unsecured or public computer.

## Related documents

---

### Document

---

#### **Welch Allyn Connectivity Server (WACS)**

Welch Allyn Connectivity Server (WACS) CD-ROM (English):  
*Welch Allyn Connectivity Server directions for use*  
*Welch Allyn Connectivity Server programmer's guide*  
*AcuityLink Clinician Notifier directions for use*

---

#### **Acuity and Mobile Acuity LT Central Monitoring System**

##### **Directions for use**

Acuity and Mobile Acuity LT Central Monitoring Systems directions for use and in-service guide CD-ROM (multilanguage):

*Acuity and Mobile Acuity LT Central Monitoring Systems directions for use*  
*Acuity Central Monitoring System in-service guide* (English)

##### **Installation guides (printed)**

*Mobile Acuity LT System installation guide* (En, Fr, Ger, Sp, It, Pol)

##### **Quick card**

*Acuity System icons* (English, printed)

---

#### **Welch Allyn Monitors**

*Micropaq Monitor directions for use* CD-ROM (multilanguage)  
*Propaq LT Monitor directions for use* CD-ROM (multilanguage)  
*Propaq CS Monitor directions for use* CD-ROM (multilanguage)  
*Propaq Encore Monitor directions for use* CD-ROM (multilanguage)  
*Welch Allyn 1500 Patient Monitor directions for use* CD-ROM (multilanguage)

---





## 2

## System overview

### Welcome!

The Acuity Central Monitoring System is a real-time patient monitoring system that collects and displays vital-sign information for multiple patients over the Welch Allyn FlexNet™ network.

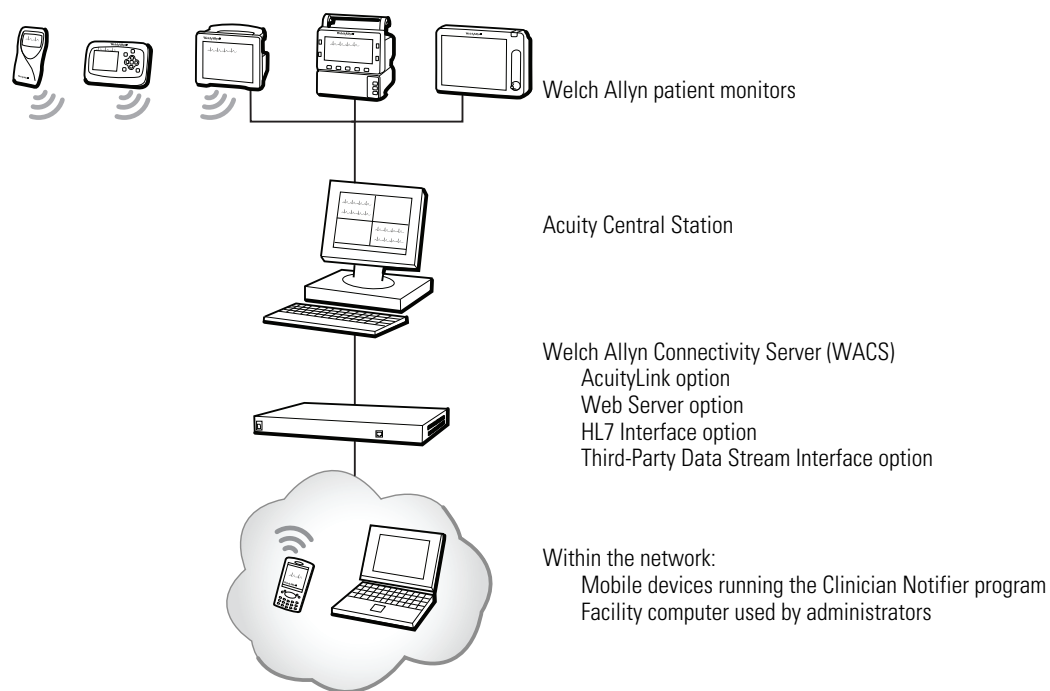

This document contains specifications intended as a guide for software developers to develop the HL7 or XML interface between a facility-controlled clinical information system (CIS or HIS) and an Acuity System. It is assumed that users of this guide are familiar with applicable HL7 standards or XML standards, and that users have standards available for reference.

For information about further configuring the WACS HL7 settings for your facility, see the *Welch Allyn Connectivity Server Directions for Use*, which describes using the WACS HL7 Manager pages to configure the HL7 interface.

## Data interface provided by the Welch Allyn Connectivity Server (WACS)

The WACS option to the Acuity Central Monitoring System is able to provide these data interface options:

- HL7 (Health Level 7) Interface option
- Third-Party Data Stream Interface option (XML format)

Either WACS data interface option can include one or both of these distinct modules.

- Inbound HL7 ADT Data module: Admit/discharge/transfer (ADT) data from your CIS or HIS to WACS. WACS uses the Acuity System network to send ADT information to the Acuity Central Monitoring System for storage.
- Outbound HL7 Vital-sign Observations module: Numeric patient vital-sign observations from WACS to your facility-controlled clinical or hospital information system (CIS or HIS).

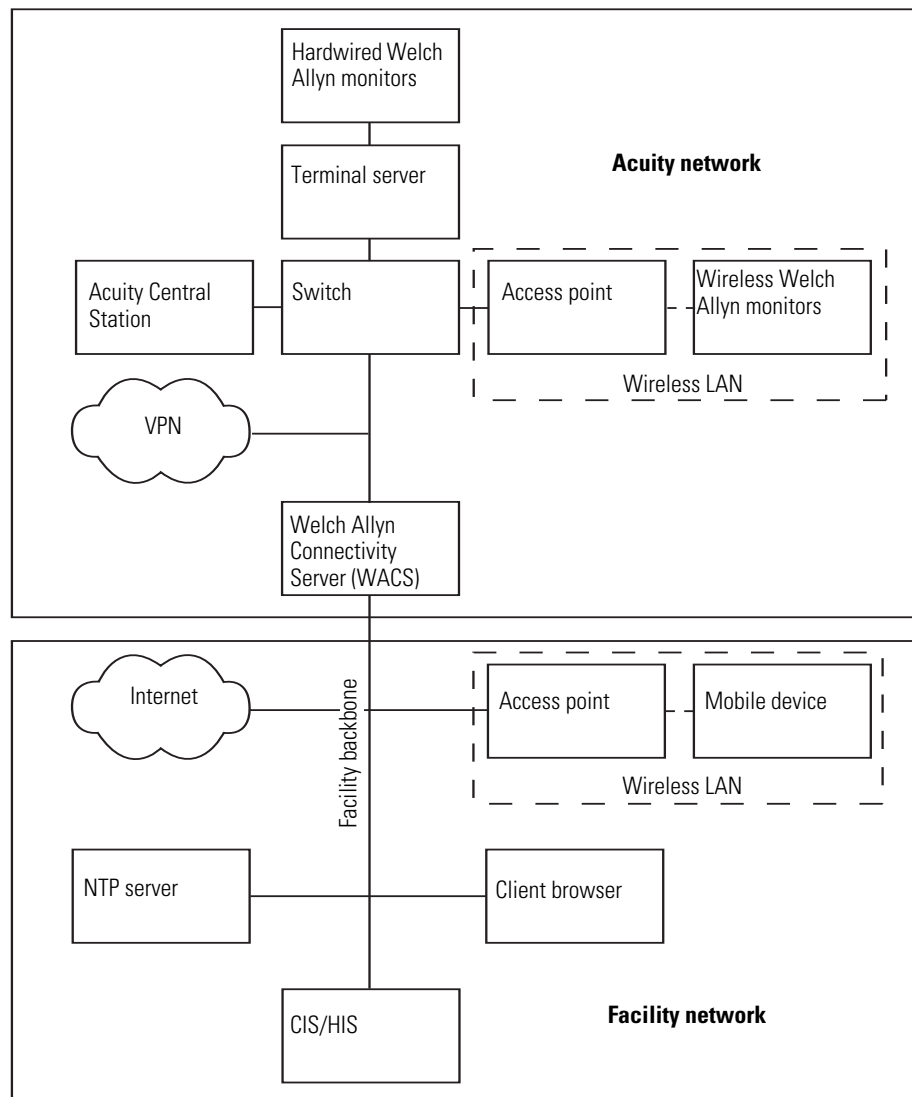

# Data transfer and storage within the Acuity System network

The Acuity System stores patient data for variable amounts of time, depending upon Acuity System license configuration.

## Data export from patient monitors to the Acuity System

Welch Allyn portable patient monitors store vital-sign data and send it to the Acuity System in the following ways:

**Table 1. Patient monitor data storage and export to the Acuity System**

<b>Patient Monitor</b>	<b>Means of data export to Acuity System</b>	<b>Mode of data export to Acuity System during normal conditions</b>	<b>Patient monitor data storage during temporary disconnection or dropout</b>	<b>Data export to Acuity System after temporary disconnection or dropout</b>
Hardwired monitors: Propaq® Encore, Propaq CS	Unshielded twisted pair (UTP)	Stream	Data stored up to monitor storage capacity	Trends data only, sent in batch mode
Hardwired Welch Allyn 1500 Patient Monitor	Ethernet	Stream	Data stored up to 24 hours	Trends data only, sent in batch mode
Wireless monitors: Propaq CS, Propaq LT and Micropaq®	802.11 wireless LAN	Stream	Propaqs: Data stored up to monitor storage capacity  Micropaq: No storage	Propaqs: Trends data only, sent in batch mode  Micropaq: data lost

## Data storage at the Acuity System

The Acuity System stores data for a period determined by the Full Disclosure license configuration.

### Storage during Acuity connection to WACS

**Table 2. Acuity System data storage configurations and Acuity System data export to WACS**

Acuity System data storage configuration	WACS capability for data receipt <sup>a</sup>
Zero hours	Continuous
24 hours	Query for most recent 24 hours
96 hours	Query for most recent 96 hours

a. Data is available for a period up to the Acuity Full Disclosure capability, but unsolicited push interfaces are usually configured to a shorter period to avoid swamping the CIS/HIS.

### Storage after Acuity disconnects from WACS or patient monitor

**Table 3. Examples of Acuity System data export after disconnection**

WACS HL7 message configuration	2-hour disconnect period	Behavior upon reconnection
Unsolicited observation (push) from WACS to CIS 15-minute intervals	Patient monitor disconnected from Acuity System	Acuity System sends 8 sets of vital-sign observations, covering the last two hours
	Or Acuity System disconnected from WACS server	

## Data exported from the Acuity System to WACS

The Acuity System exports the following vital-sign data:

**Table 4. Numeric vital-sign data exported from Acuity Systems to WACS**

Vital sign	Units	Default units	Preferred HL7 tag (OBX-3)
Heart rate	BPM (1/min)	BPM (1/min)	Heart Rate
Temperature 1, 2	DegF (°F), DegC (°C)	DegC (°C)	Temperature
SpO <sub>2</sub>	Per cent (%)	Per cent (%)	SPO2
CO <sub>2</sub> In	mmHg, kPa, %	mmHg	CO2(In)
CO <sub>2</sub> Ex	mmHg, kPa, %	mmHg	CO2(Ex)
RESP	Br/M (1/min)	Br/M (1/min)	RR/BR
NIBP (DIA / SYS / MEAN)	mmHg	mmHg	NIBP
IBP - 1 (DIA / SYS / MEAN) unlabeled arterial intracranial umbilical artery umbilical vein pulmonary artery central venous	mmHg	mmHg	IBP1 ART ICP UA UV PA CVP
IBP - 2 (DIA / SYS / MEAN) unlabeled arterial intracranial umbilical artery umbilical vein pulmonary artery central venous	mmHg	mmHg	IBP2 ART ICP UA UV PA CVP
PVCRate	PVC/Min (1/min)	PVC/Min (1/min)	PVC



# 3

## HL7 standard protocols

---

This chapter describes basic HL7 data structure as outlined in the *Health Level Seven Messaging Standard*.

Information in this chapter is organized as follows:

Health Level Seven Standard . . . . .	11
HL7 low-level protocol . . . . .	12
HL7 segment-level protocols . . . . .	12

### Health Level Seven Standard

The Welch Allyn HL7 Interface option closely follows the data structure outlined in the *Health Level Seven Version 2.4 Messaging Standard*.

The following excerpt is taken from section 7.3 and section 7.4 of this standard:

“Many report headers (OBR) may be sent beneath each patient segment, with many separate observation segments (OBX) beneath each OBR. Note segments (NTE) may be inserted after any of the above segments. The note segment applies to the entity that immediately precedes it, i.e., the patient if it follows the PID segment, the observation if it follows the OBR segment, and the individual result if it follows the OBX segment.”

One result segment (OBX) is transmitted for each vitals component (such as Heart rate or RR/BR).

For updated information regarding this standard, see [www.hl7.org/](http://www.hl7.org/).

# HL7 low-level protocol

This section describes the low-level format of HL7 packet frames.

## Packet frames

HL7 frames that are exchanged between the server and the client describe both sent and received data.

**Table 5. HL7 packet frame: low-level format**

Packet description	Content	Size (bytes)
Start block	0x0B ASCII <VT>	1
Body	variable bytes	variable
End block	0x1C ASCII <FS>	1
Carriage return	0x0D ASCII <CR>	1

## HL7 segment-level protocols

This section describes HL7 message hierarchy and delimiters, segment notation and date/time format.

### Message hierarchy and message delimiters

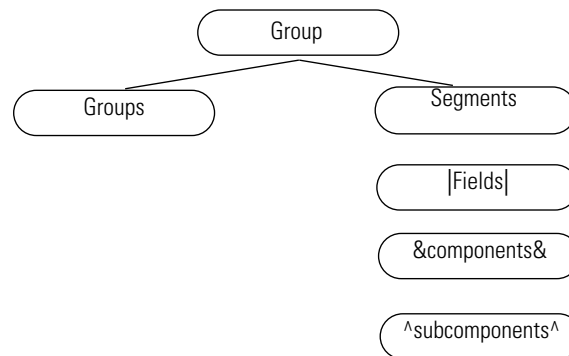

### Segment notation

**Table 6. HL7 segment notation: mandatory, optional and repeating**

Notation example	Definition
PID	This segment is mandatory.
[PID]	This segment is optional.
{IN1}	This segment is mandatory, and it can repeat.
[[NK1]]	This segment is both optional and repeating.



## Time/date in HL7 segments

When importing vital-sign data into an electronic patient-charting application, use the timestamp associated with the OBR for the vital-signs record in the chart.

### Format

Date and time in the HL7 segments are represented in this format:  
YYYYMMDDHHMMSS.mmm±TZTZ

- Displayed time is local.
- Hours are in the range 0-23.
- Seconds (SS) are followed by the following:
  - 3-digit millisecond value (which appears as 000 if no other value is provided)
  - + or a -
  - 4-digit time-zone code

### Example of HL7 time/date format:

26 January 2009, at 0.193 seconds past 12:22:02 PM, Pacific time (8 hours behind GMT):  
20090126122202.193-0800



## 4

## WACS outbound HL7 protocols

---

The WACS Outbound HL7 Vital-sign Observations module uses Java™ processes to read patient data files from an Acuity System and forward the messages to a CIS server.

This chapter describes WACS protocols used in the Outbound HL7 Observations module. The WACS protocols closely follow the data structure outlined in the *Health Level Seven Version 2.4 Messaging Standard*.

Information in this chapter is organized as follows:

Overview: Outbound HL7 Vital-sign Observations module . . . . .	16
Labels and attributes of outbound segments . . . . .	17
Outbound patient identification fields . . . . .	21
Outbound vital-sign tags and filters . . . . .	22
Reconfiguring WACS outbound observation settings . . . . .	24

# Overview: Outbound HL7 Vital-sign Observations module

Patient vital-sign observations are transferred to the CIS server in this manner:

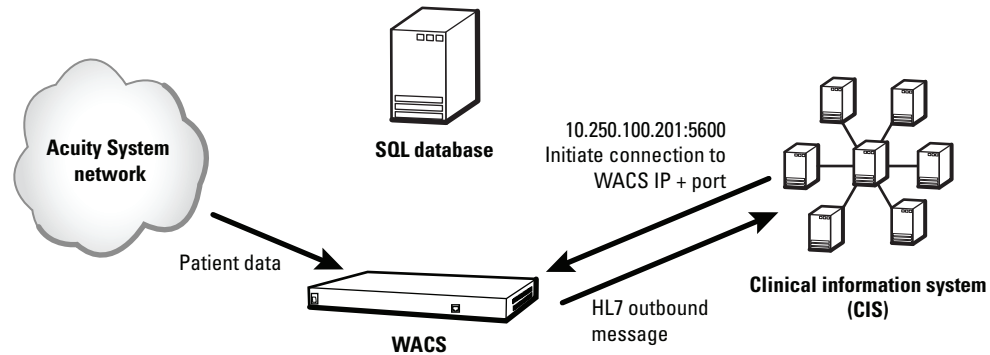

## Outbound HL7 patient data messaging

1. WACS is configured to accept requests on a preconfigured TCP port (usually in the 5600-5700 range).
2. Once a connection is established between the WACS system and the CIS, and once the optional handshake and optional authentication are complete, The HL7 session begins.
3. WACS sends observations to the CIS in one of these ways, depending on the configured model:
  - Push model: WACS sends information to the CIS at configurable intervals
  - Pull model: WACS listens for incoming queries from the CIS

The system maintains an open connection for as long as possible. Connections can be re-established if fatal errors or program crashes occur on either end. The WACS master program uses exit codes and return values of the interface components to manage child processes.

## Labels and attributes of outbound segments

The following table defines requirement labels for outbound segments.

**Table 7. Requirement labels for outbound segments**

Label	Requirement	Description
R	Required	Causes an error condition if missing
O	Optional	May be used by WACS/CIS if present
C	Conditionally Required	May cause an error condition if missing; dependent on other factors or fields
N	Not used	Causes an error condition if present
I	Ignored	Not used, whether present or missing
F	Future	Not used, whether present or missing

## HL7 attributes of OBR (observation request) segments

**Table 8. HL7 attributes – OBR – observation request segment**

SEQ	LEN	DT	OPT	RP#	TBL#	Item #	Element name	WACS requirement
1	4	SI	O			00237	Set ID - OBR	R
2	22	EI	C			00216	Placer Order Number	C
3	22	EI	C			00217	Filler Order Number	N
4	250	CE	R			00238	Universal Service Identifier	R
5	2	ID	X			00239	Priority - OBR	N
6	26	TS	X			00240	Requested Date/Time	R
7	26	TS	C			00241	Observation Date/Time	N
8	26	TS	O			00242	Observation End Date/Time	N
9	20	CQ	O			00243	Collection Volume	N
10	250	XCN	O	Y		00244	Collector Identifier	N
11	1	ID	O		0065	00245	Specimen Action Code	N
12	250	CE	O			00246	Danger Code	N
13	300	ST	O			00247	Relevant Clinical Information	N
14	26	TS	C			00248	Specimen Received Date/Time	N
15	300	CM	O		0070	00249	Specimen Source	N
16	250	XCN	O	Y		00226	Ordering Provider	N
17	250	XTN	O	Y/2		00250	Order Callback Phone Number	N
18	60	ST	O			00251	Placer Field 1	N
19	60	ST	O			00252	Placer Field 2	N
20	60	ST	O			00253	Filler Field 1	N
21	60	ST	O			00254	Filler Field 2	N
22	26	TS	C			00255	Results Rpt/Status Chng - Date/Time	N
23	40	CM	O			00256	Charge to Practice	N
24	10	ID	O		0074	00257	Diagnostic Serv Sect ID	N

**Table 8. HL7 attributes – OBR – observation request segment (continued)**

SEQ	LEN	DT	OPT	RP#	TBL#	Item #	Element name	WACS requirement
25	1	ID	C		0123	00258	Result Status	N
26	400	CM	0			00259	Parent Result	N
27	200	TQ	0	Y		00221	Quantity/Timing	N
28	250	XCN	0	Y/5		00260	Result Copies To	N
29	200	CM	0			00261	Parent	N
30	20	ID	0		0124	00262	Transportation Mode	N
31	250	CE	0	Y		00263	Reason for Study	N
32	200	CM	0			00264	Principal Result Interpreter	N
33	200	CM	0	Y		00265	Assistant Result Interpreter	N
34	200	CM	0	Y		00266	Technician	N
35	200	CM	0	Y		00267	Transcriptionist	N
36	26	TS	0			00268	Scheduled Date/Time	N
37	4	NM	0			01028	Number of Sample Containers	N
38	250	CE	0	Y		01029	Transport Logistics of Collected Sample	N
39	250	CE	0	Y		01030	Collector's Comment	N
40	250	CE	0			01031	Transport Arrangement Responsibility	N
41	30	ID	0		0224	01032	Transport Arranged	N
42	1	ID	0		0225	01033	Escort Required	N
43	250	CE	0	Y		01034	Planned Patient Transport Comment	N
44	250	CE	0		0088	00393	Procedure Code	N
45	250	CE	0	Y	0340	01316	Procedure Code Modifier	N
46	250	CE	0	Y	0411	01474	Placer Supplemental Service Information	N
47	250	CE	0	Y	0411	01475	Filler Supplemental Service Information	N

## OBR segment example

```
OBR|1|||VITALS^Vital Signs^WAP|||20090127093400.000-0800
```

## HL7 attributes of PID (patient ID) segments

**Table 9. HL7 attributes – PID – patient ID segment**

SEQ	LEN	DT	OPT	RP#	TBL#	Item#	Element name	WACS requirement
1	4	SI	O			00104	Set ID - PID	R
2	20	CX	B			00105	Patient ID	R
3	20	CX	R	Y		00106	Patient Identifier List	R
4	20	CX	B	Y		00107	Alternate Patient ID - PID	I
5	48	XPN	R	Y		00108	Patient Name	O
6	48	XPN	O	Y		00109	Mother's Maiden Name	I
7	26	TS	O			00110	Date/Time of Birth	I
8	1	IS	O		0001	00111	Sex	I
9	48	XPN	O	Y		00112	Patient Alias	I
10	80	CE	O	Y	0005	00113	Race	I
11	106	XAD	O	Y		00114	Patient Address	I
12	4	IS	B		0289	00115	County Code	I
13	40	XTN	O	Y		00116	Phone Number - Home	I
14	40	XTN	O	Y		00117	Phone Number - Business	I
15	60	CE	O		0296	00118	Primary Language	I
16	80	CE	O		0002	00119	Marital Status	I
17	80	CE	O		0006	00120	Religion	I
18	20	CX	O	Y		00121	Patient Account Number	C
19	16	ST	B			00122	SSN Number - Patient	I
20	25	DLN	O			00123	Driver's License Number - Patient	I
21	20	CX	O	Y		00124	Mother's Identifier	I
22	80	CE	O	Y	0189	00125	Ethnic Group	I
23	60	ST	O			00126	Birth Place	I
24	1	ID	O		0136	00127	Multiple Birth Indicator	I
25	2	NM	O			00128	Birth Order	I
26	80	CE	O	Y	0171	00129	Citizenship	I
27	60	CE	O		0172	00130	Veterans Military Status	I
28	80	CE	O		0212	00739	Nationality	I
29	26	TS	O			00740	Patient Death Date and Time	I
30	1	ID	O		0136	00741	Patient Death Indicator	I

### PID segment examples

Edgar A Van Goe with Primary ID 9582173 and no Amended ID:  
 PID|1|9582173|9582173||Van Goe^Edgar^A|||||||9582173

Edgar A Van Goe with Primary ID 9582173 and Amended ID 867509:  
 PID|1|867509|867509||Van Goe^Edgar^A|||||||867509

## HL7 attributes of OBX (observation/result) segments

**Table 10. HL7 attributes – OBX – observation/result segment**

SEQ	LEN	DT	OPT	RP/#	TBL#	ITEM#	Element name	WACS requirement
1	4	SI	O			00569	Set ID - OBX	R
2	2	ID	C		0125	00570	Value Type	R
3	250	CE	R			00571	Observation Identifier	R
4	20	ST	C			00572	Observation Sub-ID	C
5	65536 <sup>a</sup>	*	C	Y <sup>b</sup>		00573	Observation Value	R
6	250	CE	O			00574	Units	R
7	60	ST	O			00575	References Range	C
8	5	IS	O	Y/5	0078	00576	Abnormal Flags	C
9	5	NM	O			00577	Probability	I
10	2	ID	O	Y	0080	00578	Nature of Abnormal Test	N
11	1	ID	R		0085	00579	Observation Result Status	N
12	26	TS	O			00580	Date Last Observation Normal Value	N
13	20	ST	O			00581	User Defined Access Checks	N
14	26	TS	O			00582	Date/Time of the Observation	R
15	250	CE	O			00583	Producer's ID	N
16	250	XCN	O	Y		00584	Responsible Observer	N
17	250	CE	O	Y		00936	Observation Method	N
18	22	EI	O	Y		01479	Equipment Instance Identifier	N
19	26	TS	O			01480	Date/Time of the Analysis	N

a. The length of the observation field is variable, depending upon value type. See *OBX-2 value type*.

b. May repeat for multipart, single answer results with appropriate data types, e.g., CE, TX, and FT data types.

### OBX segment example

```
OBX|1|ST|Heart Rate^Heart Rate^WAP||80|^BPM|||||||20090127093400.000-0800
```



## Outbound patient identification fields

Patient ID information is confirmed at the Acuity Central Station in the Patient ID Setup window. WACS forwards an outbound patient ID segment that includes at least one of these ID fields: PID-2, PID-3, and PID-18. By default, all of the fields are populated.

Export multiple ID fields from WACS, such as name and ID number. This enables detection of obvious identification errors. Since monitors can move easily from location to location, patient room number alone is an unreliable means of identifying patients.

WACS can export these patient ID fields:

- Patient ID number: A primary identification number, such as a medical record number, account number or a patient's personal ID number (such as a social security number). If this number is input incorrectly, it cannot be altered.
- Amended patient ID number: An alternate ID that can be associated with the patient. This ID can be entered in the Acuity System Patient ID Setup window, in the Amended ID field.
- Patient last name
- Patient first name
- Patient middle initial

**Note** The Acuity System accepts middle initial only (not middle name).

- Patient location: A room number

## Outbound vital-sign tags and filters

WACS generates the vital-sign tags and filters described in this section.

By default, missing tags or tag errors cause the HL7 interface to reject the request or query. If part of a message or reply is valid, WACS ignores or rejects the erroneous portion and returns only the valid reply.

This setting is configurable in the WACS HL7 Manager pages (see the *Welch Allyn Connectivity Server directions for use*).

### Vital-sign tags

Vital-sign tags include vital sign name tags, unit tags and optional status fields.

**Table 11. WACS HL7 sublevel tags for vital signs (OBX-4)**

Vital-sign sub-level	HL7 OBX-4 tag
Temperature 1 (Temperature)	1
Temperature 2 (Temperature)	2
Systolic Blood Pressure (IBP-1, IBP-2, NIBP)	SYS
Diastolic Blood Pressure (IBP-1, IBP-2, NIBP)	DIA
Mean Blood Pressure (IBP-1, IBP-2, NIBP)	MEAN

**Table 12. WACS HL7 tags for units (OBX-6)**

BPM (1 / min)
DegC (°C)
DegF (°F)
Percent (%)
mmHg
kPa
Br/M (1 / min)
PVC/Min (1 / min)

**Table 13. Optional WACS HL7 status fields (OBX-8 abnormal flag segment)**

OBX-8 abnormal flag segment	Patient monitor/Acuity System notation	Description
		Valid value
<	(---)	Under range, below absolute low on the instrument scale
>	(+++)	Over range, above absolute high on the instrument scale
?	Invalid	For example, no valid SpO2 numeric is produced when the SpO2 sensor is removed from the patient's finger.

## Vital-sign numerics filters

One of the following vital-sign numerics filters must be configured for the WACS server:

**Table 14. WACS vital-sign filters**

Filter	Function
Median	<p>For an odd number of sample points, WACS sorts the data in descending order and returns the middle (median) data point. For example, for the values 56, 72, 96, 82 and 78, the returned value is 78.</p> <p>For an even number of sample points, WACS returns either the average (mean) or one of the two middle points. For example, for the values 56, 72, 70, 96, 82 and 78, the returned value is either the mean value (76) or one of the middle values (72 or 78).</p>
Closest	<p>Returns the data closest to the given reference point.</p> <p>Example: Heart rate values are calculated every minute over a period of five minutes. For example, heart rate values of 56, 72, 96, 82, and 78 are collected, and then the HL7 message is constructed at the five-minute reference point. The HL7 message is contains only the heart rate value of 78, which is the value closest to the reference point.</p>

# Reconfiguring WACS outbound observation settings

Welch Allyn preconfigured your Welch Allyn Connectivity Server (WACS) based on your facility's specified requirements. Once your system is built and programmed, and once data is flowing from the WACS server to the CIS, you can adjust and customize WACS default settings.

## Common outbound setting adjustments

Common HL7 setting adjustments are as follows:

- HL7 version
- Seconds of historical data retrieval
- Push intervals
- Push on event settings
- Number of resend attempts
- Observations per patient
- Patients per message
- Observation label formats
- OBX sub-IS specification

## Accessing the WACS program HL7 Manager pages

For detailed instructions on accessing and using the WACS HL7 Manager pages, see the *Welch Allyn Connectivity Server (WACS) directions for use*.

That document also provides message examples that show message formats before and after HL7 setting adjustments are made.

Only WACS users who have been designated with a WACS biomedical engineer role can access the WACS HL7 pages.

Welcome, Hospital Administrator Home | Log Out

ADMINISTRATOR

Overview User Manager Clinician Notifier Manager **HL7 Manager** Upgrade Manager Reboot Manager

**In this section:**

- HL7 Manager
  - HL7 General
    - MSH Segment
    - MSA Segment
    - ERR Segment
    - PID Segment
    - PV1 Segment
    - OBR Segment
    - OBX Segment
    - Push On Event
    - Observation Identifier

**HL7 Manager**  
Configure the general settings for the Query Manager. For more information on default ranges for any variable, simply click the entry in the table below.

Reboot or HL7 Restart is required for these changes to take effect.

Save Changes Reset

Description	Default Value	Current Value	New Value
Numeric Data Filter	Median	Closest	Closest
Numeric Data Filter for NIBP	Closest	Median	Median
String PAD	--	--	--

Save Changes Reset

You can reconfigure settings by taking these steps:

1. Access the WACS program via certain internet browsers on any computer in your facility's intranet
2. Open the WACS HL7 Manager pages in the WACS program



## 5

## WACS outbound HL7 messages

---

This chapter provides this information:

- Description of outbound WACS observation segments and acknowledgement segments and examples of observation messages and acknowledgement messages
- Descriptions of outbound WACS query segments and reply segments and examples of query messages and reply messages

Certain message formats can vary based on settings made in the WACS program HL7 Manager pages. To view examples of message format changes that occur after specific HL7 settings are adjusted, see the *Welch Allyn Connectivity Server (WACS) directions for use*.

The information in this chapter is organized as follows:

Unsolicited observation message ORU^R01/ACK^R01 . . . . .	28
Query for results of observation message QRY^R02/ORF^R04 . . . . .	30
Query by parameter QBP^Q11/RSP^Z90 . . . . .	33
Query by ID . . . . .	36
Query by location . . . . .	38

# Unsolicited observation message

## ORU^R01/ACK^R01

### Segments

ORU^R01 message segments

**Table 15. ORU^R01 unsolicited observation message**

Segment	Description	WACS segment requirement
MSH	Message Header	R
{		
[		
PID	Patient Identification	R
[PD1]	Additional Demographics	I
{{NK1}}	Next of Kin/Associated Parties	I
{{NTE}}	Notes and Comments	I
[		
PV1	Patient Visit	C
[PV2]	Patient Visit - Additional Info	I
]		
]		
{		
[ORC]	Order common	I
OBR	Observations Report ID	R
{{NTE}}	Notes and comments	I
[CTD]	Contact Data	I
{		
[OBX]	Observation/Result	R
{{NTE}}	Notes and comments	I
}		
{{FT1}}	Financial Transaction	I
{{CTI}}	Clinical Trial Identification	I
}		
}		
[DSC]	Continuation Pointer	I



## ACK^R01 acknowledgement segments

Each ORU message must be acknowledged with a corresponding ACK^R01 acknowledgement message.

If no acknowledgement is received, the ORU message is retransmitted at a configurable interval (default=30 seconds). The message is retransmitted until it has been sent a configurable number of times (default=5) or until an acknowledgement is received.

**Table 16. ACK^R01 acknowledgment message—required**

Segment	Description
<b>MSH</b>	<b>Message header</b>
MSH-9	ACK^R01
MSH-11	P
MSH-12	Version (2.3, 2.3.1, 2.4)
<b>MSA</b>	<b>Message acknowledgement</b>
MSA-1	AA
MSA-2	Original message ID

## ORU/ACK message and acknowledgement example

### ORU^R01 message:

```
<Tue Jan 27 09:36:02 2009>      HL7# HL7Log Initiator sending message:
MSH|^~\&|WAP^WAP|||20090127093601.105-0800||ORU^R01|20090127093601106c5|P|2.4
PID|1|867509|867509||Van Goe^Edgar^A|||||||867509
OBR|1|||VITALS^Vital Signs^WAP|||20090127093400.000-0800
OBX|1|ST|Heart Rate^Heart Rate^WAP||80|^BPM|||||||20090127093400.000-0800
OBX|2|ST|Temperature^Temperature^WAP|1|98.6|^F|||||||20090127093400.000-0800
OBX|3|ST|Temperature^Temperature^WAP|2|97.5|^F|||||||20090127093400.000-0800
OBX|4|ST|SPO2^SPO2^WAP||97|^%|||||||20090127093400.000-0800
OBX|5|ST|CO2 (In)^CO2 (In)^WAP||0.0|^%|||||||20090127093400.000-0800
OBX|6|ST|CO2 (Ex)^CO2 (Ex)^WAP||5.0|^%|||||||20090127093400.000-0800
OBX|7|ST|RR/BR^RR/BR^WAP||12|^Br/M|||||||20090127093400.000-0800
OBX|8|ST|PVC^PVC^WAP||0.0|^PVC/Min|||||||20090127093400.000-0800
```

### ACK^R01 acknowledgement:

```
<Tue Jan 27 09:36:02 2009>      HL7# HL7Log Initiator received message:
MSH|^~\&|||WAP^WAP||20090127093601.105-0800||ACK^R01|20090127093601106c5|P|2.4
MSA|AA|20090127093601106c5
```

# Query for results of observation message QRY^R02/ORF^R04

This query-response model supports “Solicited Poll” and “User Initiated Query”.

## Segments

QRY^R02 query segments

**Table 17. QRY^R02 query for results of observation message**

Segment	Description	WACS segment requirement	Note
MSH	message header	R	
QRD	query definition	R	
QRF	query filter	C	implementation-dependent

### Segment QRD: Query definition

QRD-1: Ignored  
 QRD-2: Required (must be “R”)  
 QRD-3: Required (must be “I”)  
 QRD-4: Ignored  
 QRD-5: Ignored  
 QRD-6: Ignored  
 QRD-7: Ignored  
 QRD-8: Conditionally required (Patient IDs)  
 QRD-9: Required (must be “RES”)  
 QRD-10: Ignored  
 QRD-11: Ignored  
 QRD-12: Ignored

### Segment QRF: Query filter

QRF-1: Conditionally required (Unit Name)  
 QRF-2: Ignored  
 QRF-3: Ignored  
 QRF-4: Required (Data Requested)  
 QRF-5: Conditionally required (Room and Bed)  
 QRF-6: Ignored  
 QRF-7: Ignored  
 QRF-8: Ignored  
 QRF-9: Required (Start/End Time and Interval)

## ORF^R04 reply segments

**Table 18. ORF^R04 observational report (reply)**

<b>Segment</b>	<b>Description</b>	<b>WACS segment requirement</b>
MSH	Message Header	R
MSA	Message Acknowledgment	R
ORD	Query Definition	R
[ORF]	Query Format	C
{		
[		
PID	Patient ID	R
PV1	Patient location (enabled only for patient-based site)	
{{NTE}}	Notes and Comments	I
]		
{		
OBR	Observation request	R
{{NTE}}	Notes and comments	I
{		
[OBX]	Observation/Result	R
{{NTE}}	Notes and comments	I
}		
{{CTI}}	Clinical Trial Identification	I
}		
}		
[ERR]	Error	C
[QAK]	Query Acknowledgement	C
[DSC]	Continuation Pointer	I

## QRY/ORF query and reply example

Get the heart rate and respiration rate of Patient ID GA003560 from 2003/06/24 11:50:00 to 2003/06/24 11:50:02 interval of 1 sec.

### QRY^R02 query:

```
MSH|^~\&|Van Goe^Edgar^A|||20030624121618.151-0800||QRY^R02|200306241216181517|P|2.4
QRD|20030624121618.191-0800|R||Q1056482178191|||GA003560|RES
QRF|||Heart Rate~RR/BR|||^^&1^^20030624115000-0800^20030624115002-0800
```

### ORF^R04 reply:

```
MSH|^~\&|WAP^WAP|||20030624121744.994-0800||ORF^R04|20030624121744995a|P|2.4
QRD|20030624121744.615-0800|R||Q1056482264615|||GA003560|RES
QRF|||Heart Rate~RR/BR|||^^&1^^20030624115000-0800^20030624115002-0800
PID|1|GA003560|GA003560
OBR|1|||VITALS^Vital Signs^WAP|||20030624115001.000-0800
OBX|1|ST|Heart Rate^Heart Rate^WAP||80.0|^BPM|||20030624115000.000-0800
OBX|2|ST|RR/BR^RR/BR^WAP||20.0|^Br/M|||20030624115000.000-0800
OBR|2|||VITALS^Vital Signs^WAP|||20030624115002.000-0800
OBX|1|ST|Heart Rate^Heart Rate^WAP||80.0|^BPM|||20030624115001.000-0800
OBX|2|ST|RR/BR^RR/BR^WAP||20.0|^Br/M|||20030624115001.000-0800
```

# Query by parameter

## QBP^Q11/RSP^Z90

### Segments

QBP^Q11 query segments and their HL7 attributes

**Table 19. QBP^Q11—query by parameter message**

Segment	Description	WACS segment requirement
MSH	Message Header	R
QPD	Query Parameter Definition Segment	R
[...]	Optional Query by Example Segments	I
RCP	Response Control Parameters	I
[DSC]	Continuation Pointer	I

#### Segment QPD: Query parameter definition

QPD-1: Ignored

QPD-2: Ignored

QPD-3: Conditionally required (Patient IDs)

QPD-4: Conditionally required (Patient Location)

QPD-5: Required (Start/End Time and Interval)

QPD-6: Required (Data Requested)

**Table 20. HL7 attributes—QPD (query parameter definition)**

SEQ	LEN	DT	OPT	RP	TBL#	Item#	Element name
1	250	CE	R		0471	01375	Message Query Name
2	32	ST	C			00696	Query Tag
3		CX	C	Y			Patient IDs
4		PL	C	Y			Patient Location
5		TQ	R	N			Timing Quantity
6		ST	R	Y			Parameter

## RSP^Z90 reply segments

**Table 21. RSP^Z90 - segment pattern response**

Segment	Description	Group control	Comment
MSH	Message Header		
MSA	Message Acknowledge		
[ERR]	Error		
QAK	Query Acknowledge		
QPD	Query Parameter Definition		
RCP	Response Control Parameter		
{			Query Result Cluster
[		PIDG	Begin PID Group
PID	Patient Identification		
[PDI]	Additional Demographics		
[{{NK1}}	Next of Kin/Associated Parties		
[{{NTE}}	Notes and Comments (for PID)		
[PV1	Patient Visit		
[PV2]]	Patient Visit - Additional Info		
]			End PID Group
{		ORCG	Begin ORC Group
ORC	Common Order		Each ORC/OB combination constitutes a hit.
OBR	Observation Report ID		
[{{NTE}}	Notes and comments (for ORC/OBR)		
[CTD]	Contact Data		
{		OBXG	Begins OBX Group
[OBX]	Observation/Result		
[{{NTE}}	Notes and Comments (for OBX)		
}			End OBX Group
}			End ORC Group
}			End Query Results
DSC	Continuation Pointer		

## QBP/RSP query and reply example

Get Heart Rate and RR/BR of Patient ID GA003560 from 2003/06/24 11:50:00 to 2003/06/24 11:50:02 interval of 1 sec.

### QBP^Q11 query:

```
MSH|^~\&|VanGoe^Edgar^A|||20030624121816.101-0800||QBP^Q11|20030624121816101b|P|2.4
QPD||GA003560||^&1^^20030624115000-0800^20030624115002-0800|Heart Rate~RR/BR
RCP
```

### RSP^Z90 reply:

```
MSH|^~\&|WAP^WAP|||20030624121817.248-0800||RSP^Z90|20030624121817250c|P|2.4
QPD||GA003560||^&1^^20030624115000-0800^20030624115002-0800|Heart Rate~RR/BR
PID|1|GA003560|GA003560
OBR|1||VITALS^Vital Signs^WAP||20030624115001.000-0800
OBX|1|ST|Heart Rate^Heart Rate^WAP||80.0|^BPM|||||20030624115000.000-0800
OBX|2|ST|RR/BR^RR/BR^WAP||20.0|^Br/M|||||20030624115000.000-0800
OBR|2||VITALS^Vital Signs^WAP||20030624115002.000-0800
OBX|1|ST|Heart Rate^Heart Rate^WAP||80.0|^BPM|||||20030624115001.000-0800
OBX|2|ST|RR/BR^RR/BR^WAP||20.0|^Br/M|||||20030624115001.000-0800
```

## Query by ID

This section covers these two formats for Query by ID:

- QRY/ORF
- QBP/RSP

### QRY/ORF format

QRY^R02 query segments

#### Segment QRD: Query definition

QRD-2: R  
 QRD-3: I  
 QRD-8: List of Patient's IDs  
 QRD-9: RES

#### Segment QRF: Query filter

QRF-4: List of Data Requested  
 QRF-9: Start/End Time and Interval

QRY/ORF query and reply example

Get the heart rate and respiration rate of Patient ID GA003560 from 2003/06/24 11:50:00 to 2003/06/24 11:50:02 interval of 1 sec.

#### QRY query:

```
MSH|^~\&|Van Goe^Edgar^A||||20030624121618.151-0800||QRY^R02|200306241216181517|P|2.4
QRD|20030624121618.191-0800|R||Q1056482178191||||GA003560|RES
QRF||||Heart Rate~RR/BR||||^&1^^20030624115000-0800^20030624115002-0800
```

#### ORF reply:

```
MSH|^~\&|WAP^WAP||||20030624121744.994-0800||ORF^R04|20030624121744995a|P|2.4
QRD|20030624121618.191-0800|R||Q1056482178191||||GA003560|RES
QRF||||Heart Rate~RR/BR||||^&1^^20030624115000-0800^20030624115002-0800
PID|1|GA003560|GA003560
OBR|1|||VITALS^Vital Signs^WAP|||20030624115001.000-0800
OBX|1|ST|Heart Rate^Heart Rate^WAP||80.0|^BPM|||||20030624115000.000-0800
OBX|2|ST|RR/BR^RR/BR^WAP||20.0|^Br/M|||||20030624115000.000-0800
OBR|2|||VITALS^Vital Signs^WAP|||20030624115002.000-0800
OBX|1|ST|Heart Rate^Heart Rate^WAP||80.0|^BPM|||||20030624115001.000-0800
OBX|2|ST|RR/BR^RR/BR^WAP||20.0|^Br/M|||||20030624115001.000-0800
```



## QBP/RSP format

QBP^Q11 query segments

### Segment QPD: Query parameter definition

QPD-3: List of Patient's ID

QPD-5: Required (Start/End Time and Interval)

QPD-6: List of Data Requested

QBP/RSP query and reply example

### QBP query:

```
MSH|^~\&|VanGoe^Edgar^A|||20030624121816.101-0800||QBP^Q11|20030624121816101b|P|2.4
QPD||GA003560|^&1^^20030624115000-0800^20030624115002-0800|HR~RR
RCP
```

### RSP reply:

```
MSH|^~\&|WAP^WAP|||20030624121817.248-0800||RSP^Z90|20030624121817250c|P|2.4
QPD||GA003560|^&1^^20030624115000-0800^20030624115002-0800|HR~RR
PID|1|GA003560|GA003560
OBR|1||VITALS^Vital Signs^WAP||20030624115001.000-0800
OBX|1|ST|Heart Rate^Heart Rate^WAP||80.0|^BPM|||||20030624115000.000-0800
OBX|2|ST|RR/BR^RR/BR^WAP||20.0|^Br/M|||||20030624115000.000-0800
OBR|2||VITALS^Vital Signs^WAP||20030624115002.000-0800
OBX|1|ST|Heart Rate^Heart Rate^WAP||80.0|^BPM|||||20030624115001.000-0800
OBX|2|ST|RR/BR^RR/BR^WAP||20.0|^Br/M|||||20030624115001.000-0800
```

## Query by location

This section covers these two formats for Query by location:

- QRY/ORF
- QBP/RSP

### QRY/QRF format

#### QRY^R02 query segments

Segment QRD: Query definition

QRD-2: R

QRD-3: I

QRD-9: Res

#### Segment QRF: Query filter

QRF-1: List of Patient's Unit - point of care

QRF-4: List of Data Requested

QRF-5: List of Patient's Room - Room + Bed

QRF-9: Required (Start/End Time and Interval)

#### QRY/ORF query and reply example

Get the heart rate and respiration rate of Patient in Unit MEDICAL Room 1310A from 20030624115000 to 20030624115002 interval of 1 sec.

#### QRY query:

```
MSH|^~\&|Van Goe^Edgar^A|||20030624120505.544-0800||QRY^R02|20030624120505544e|P|2.4
QRD|20030624120505.544-0800|R||Q1056481505544|||RES
QRF|MEDICAL||Heart Rate~RR/BR|1310A|||^&1^^20030624115000-0800^20030624115002-0800
```

#### ORF reply:

```
MSH|^~\&|WAP^WAP|||20030624121744.994-0800||ORF^R04|20030624121744995a|P|2.4
QRD|20030624120505.544-0800|R||Q1056481505544|||RES
QRF|MEDICAL||Heart Rate~RR/BR|1310A|||^&1^^20030624115000-0800^20030624115002-0800
PID|1|GA003560|GA003560
OBR|1||VITALS^Vital Signs^WAP|||20030624115001.000-0800
OBX|1|ST|Heart Rate^Heart Rate^WAP||80.0|^BPM|||20030624115000.000-0800
OBX|2|ST|RR/BR^RR/BR^WAP||20.0|^Br/M|||20030624115000.000-0800
OBR|2||VITALS^Vital Signs^WAP|||20030624115002.000-0800
OBX|1|ST|Heart Rate^Heart Rate^WAP||80.0|^BPM|||20030624115001.000-0800
OBX|2|ST|RR/BR^RR/BR^WAP||20.0|^Br/M|||20030624115001.000-0800
```

## QBP/RSP format

### QBP^Q11 segment definition

#### Segment QPD: Query parameter definition

QPD-4: List of Patient's Location  
 QPD-5: Start/End Time and Interval  
 QPD-6: List of Data Requested

### QBP^RSP query and reply example

Get the heart rate and respiration rate of Patient in Unit MEDICAL Room 1310A from 20030624115000 to 20030624115002 interval of 1 sec.

#### QBP query:

```
MSH|^~\&|VanGoe^Edgar^A||||20030624121816.101-0800||QBP^Q11|20030624121816101b|P|2.4
QPD||||MEDICAL^1310A|^&1^^20030624115000-0800^20030624115002-0800|HeartRate~RR/BR
RCP
```

#### RSP reply:

```
MSH|^~\&|WAP^WAP||||20030624121817.248-0800||RSP^Z90|20030624121817250c|P|2.4
QPD||||1310A|^&1^^20030624115000-0800^20030624115002-0800|Heart Rate~RR/BR
PID|1|GA003560|GA003560
PV1|1|MEDICAL^1310A
OBR|1||||VITALS^Vital Signs^WAP|||20030624115001.000-0800
OBX|1|ST|Heart Rate^Heart Rate^WAP||80.0|^BPM|||||20030624115000.000-0800
OBX|2|ST|RR/BR^RR/BR^WAP||20.0|^Br/M|||||20030624115000.000-0800
OBR|2||||VITALS^Vital Signs^WAP|||20030624115002.000-0800
OBX|1|ST|Heart Rate^Heart Rate^WAP||80.0|^BPM|||||20030624115001.000-0800
OBX|2|ST|RR/BR^RR/BR^WAP||20.0|^Br/M|||||20030624115001.000-0800
```



# 6

## Inbound ADT HL7 messages

---

If your facility includes the WACS Inbound HLT ADT Data module, patient information fields in Acuity System patient identification windows can autopopulate with admit/discharge/transfer (ADT) data from your CIS.

The information in this chapter is organized as follows:

Overview: Inbound HL7 ADT Data module . . . . .	42
How an Acuity System uses ADT information . . . . .	43
ADT messages accepted and stored by WACS . . . . .	46
Examples of ADT messages . . . . .	52
Reconfiguration of ADT services . . . . .	54

# Overview: Inbound HL7 ADT Data module

ADT information is transferred to the WACS server in this sequence:

## Patient identification process

1. At Acuity System, open Patient ID Setup window.
2. Insert patient ID number.
3. Press Enter on keyboard.  
Acuity queries Patient Name server and then the WACS SQL database for demographics including patient name and patient location.
4. Respond to patient confirmation prompt.  
Remaining patient fields autopopulate.

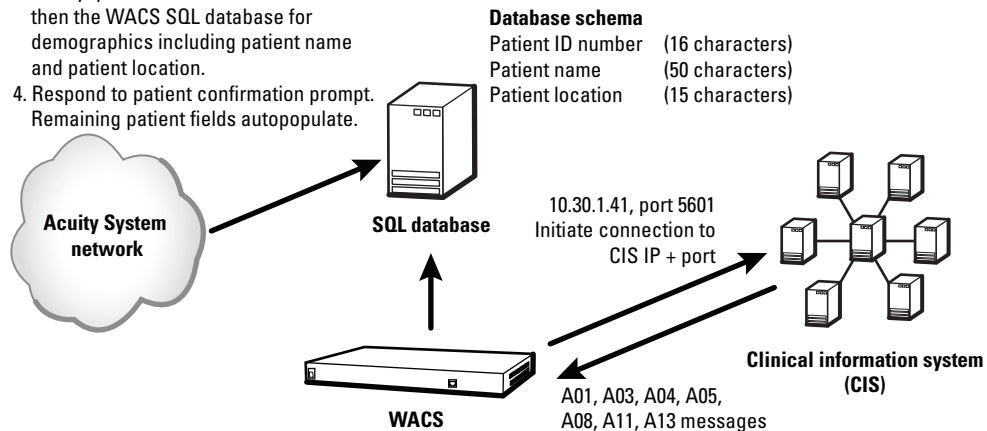

## Inbound HL7 ADT messaging

1. WACS initiates a connection to a facility's CIS on a preconfigured TCP port (usually in the range of 5600-5700).
2. Once a session is established, WACS listens for and accepts particular ADT message types from the CIS.
3. WACS updates and stores the data on a local SQL database.

# How an Acuity System uses ADT information

When a facility's CIS sends a patient's ADT information to WACS, the Acuity System uses the ADT information to autopopulate identification fields in the patient's Acuity System patient ID setup windows.

## Where a patient ID number is entered

An Acuity System user enters a patient ID number in one of these two places to confirm a new patient into the Acuity System:

- At the Acuity Central Station, in the Patient ID Setup window

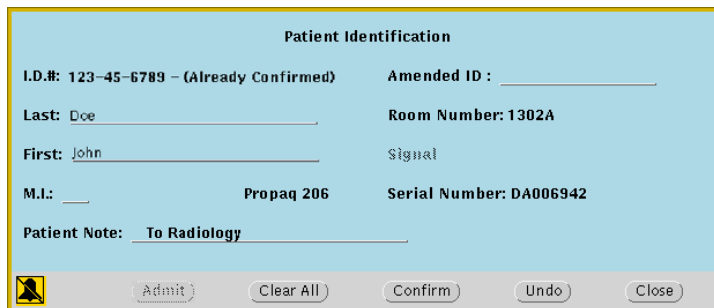

- For systems that include the WACS option with the AcuityLink option, at a mobile device running the AcuityLink Clinician Notifier program, in the Setup Patient ID screen.

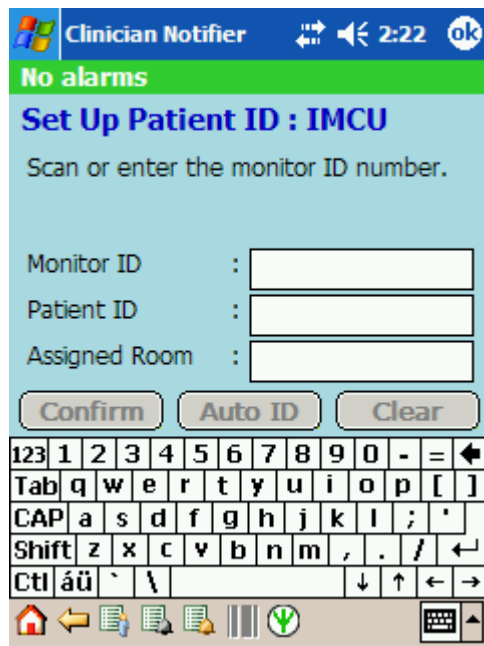

## Sequence of events when ID number is entered

This is the sequence of events that occurs within Acuity Systems that include the WACS option with the Inbound HL7 ADT module.

1. In a patient ID setup window, the user enters the patient ID number or an amended patient ID number and presses the Return or Enter key.
2. The Acuity System queries the Acuity System patient name server daemon (PNSD) for the ID number(s) and patient information associated with the number(s).

If a match is not found, the Acuity System queries the WACS database (SQL) for the ID number(s) and patient information associated with the number(s).

3. At the Acuity Central Station in the Patient ID Setup window, the Acuity System responds in one of these ways:
  - If no associated information was found, the cursor moves to the next field in the window.
  - If associated information was found, this confirmation message appears within two seconds.

The screenshot displays a patient ID setup window with a yellow border. At the top left, the patient ID is entered as '+5267'. The top right corner shows 'ID Not Confirmed'. The window is divided into several sections:

- ECG Section:** Shows a simulated ECG waveform for lead II. The y-axis is labeled '1mv' and the x-axis is labeled 'V'. The text 'SIMULATING' is visible in the top right of this section.
- Vital Signs Section:** Displays 'HR 80' and 'T1 98.6 °F'. The 'RR' field is empty.
- Match Confirmation Section:** A light blue box contains the text 'ID Matches Existing Patient Entry'. Below this, the following information is displayed:
 

Patient ID:	76803
Amended ID:	
Name:	Sophia Schamber
Room:	6A
- Navigation Section:** At the bottom, there is an 'ID' icon, an 'Accept' button, and a 'Go Back' button.

The bottom of the window features a yellow bar with the text 'Enter or Confirm Patient ID'.

4. The user responds in one of these ways:
  - If the user clicks **Accept**, the remaining fields of the window autopopulate, and existing information in the fields is replaced.  
The autopopulate action cannot be undone.
  - If the user clicks **Go Back**, the user can manually type the correct information into the blank text fields.
5. The user clicks **Confirm**.  
The patient information is distributed and confirmed.



## Rules regarding Acuity System patient IDs

These rules apply within the Acuity System:

- A patient ID number, an amended ID number or both may be entered.
- Letter case is ignored when ID numbers are compared to the PSND and WACS databases.
- An autopopulate search can match a currently monitored Acuity System patient or a patient discharged from the Acuity System for a period of 24-96 hours (depending upon the system's Full Disclosure configuration).
- After autopopulated information is confirmed, it can be modified. ID numbers can be revised with an amended ID number, and amended ID numbers can be amended.

For more information about entering and revising patient information in the Acuity System, see the *Acuity and Mobile Acuity LT Central Monitoring Systems directions for use*.

# ADT messages accepted and stored by WACS

WACS accepts the message types and formats described in this section.

## Accepted message types

WACS receives and stores these types of messages. Welch Allyn suggests that you consider configuring your CIS/HIS ADT server to block messages other than these.

- ADT/ACT - Admit/visit notification (event A01)
- ADT/ACK - Discharge/end visit (event A03)
- ADT/ACK - Register a patient (event A04)
- ADT/ACK - Pre-admit a patient (event A05)
- ADT/ACK - Update patient information event (event A08).
- ADT/ACK - Cancel admit/visit notification (event A11)
- ADT/ACK - Cancel discharge/end visit (event A13)

**Note** The Acuity System accepts middle initial only (not middle name) in messages.

## Accepted message formats

WACS accepts standard HL7 2.3-2.4 delimiters and data types, as defined in this section, taken from the *Health Level Seven Implementation Support Guide for HL7 Standard Version 2.3*.

### Delimiters

The interface parses incoming messages for delimiters, and the delimiters might differ in each message.

This section enables you to select and document which delimiters will be used in your interface, and to identify related issues early (for example, conflicts with ASCII characters that have special meaning in EBCDIC).

**Table 22. Delimiters**

	<b>HL7</b>	<b>System A</b>	<b>System B</b>
Segment terminator	<CR>	<CR>	<CR>
Field separator	(hex 0D)		
Component separator	^		
Sub-component separator	&		
Repetition Separator	~		
Escape Character	\		

## Data types

The HL7 Standard allows for different data formats for each of the following data types. This section documents general attributes of each data format.

**Table 23. Data type descriptions**

Data type	Definition	Data format attributes and notes
<b>Alphanumeric</b>		
ST	String	
TX	Text data	
FT	Formatted text	
<b>Numerical</b>		
CQ	Composite quantity with units	<quantity (NM)> ^ <units (CE)>
MO	Money	<quantity (NM)> ^ <denomination (ID)>
NM	Numeric	
SI	Sequence ID	
SN	Structured numeric	<comparator> ^ <num1 (NM)> ^ <separator/suffix> ^ <num2 (NM)>
<b>Identifier</b>		
IS	Coded values for HL7 tables	
IS	Coded value for user-defined tables	
HD	Hierarchic designator	<namespace ID (IS)> ^ <universal ID (ST)> ^ <universal ID type (ID)> Used only as part of EI and other data types.
EI	Entity identifier	<entity identifier (ST)> ^ <namespace ID (IS)> ^ <universal ID (ST)> ^ <universal ID type (ID)>
RP	Reference pointer	<pointer (ST) > ^ < application ID (HD)> ^ <type of data (ID)> ^ <subtype (ID)>
PL	Person location	<point of care (IS)> ^ <room (IS)> ^ <bed (IS)> ^ <facility (HD)> ^ < location status (IS) > ^ <person location type (IS)> ^ <building (IS)> ^ <floor (IS)> ^ <location description (ST)>
PT	Processing type	<processing ID (ID)> ^ <processing mode (ID)>
<b>Date/Time</b>		
DT	Date	YYYY[MM[DD]]
TM	Time	HH[MM[SS[S(S(S(S))))]][+/-ZZZZ]
TS	Time stamp	YYYY[MM[DD][HHMM[SS[S(S(S(S(S(S(S(S))))))]]]][+/-ZZZZ] ^ <degree of precision>

**Table 23. Data type descriptions**

Data type	Definition	Data format attributes and notes
<b>Code values</b>		
CE	Coded element	<identifier (ST)> ^ <text (ST)> ^ <name of coding system (ST)> ^ <alternate identifier (ST)> ^ <alternate text (ST)> ^ <name of alternate coding system (ST)>
CF	Coded element with formatted values	<identifier (ID)> ^ <formatted text (FT)> ^ <name of coding system (ST)> ^ <alternate identifier (ID)> ^ <alternate formatted text (FT)> ^ <name of alternate coding system (ST)>
CK	Composite ID with check digit	<ID number (NM)> ^ <check digit (NM)> ^ <code identifying the check digit scheme employed (ID)> ^ < assigning authority (HD)>
CN	Composite ID number and name	<ID number (ST)> ^ <family name (ST)> ^ <given name (ST)> ^ <middle initial or name (ST)> ^ <suffix (e.g., JR or III) (ST)> ^ <prefix (e.g., DR) (ST)> ^ <degree (e.g., MD) (ST)> ^ <source table (IS)> ^ <assigning authority (HD)>
CX	Extended composite ID with check digit	<ID (ST)> ^ <check digit (ST)> ^ <code identifying the check digit scheme employed (ID)> ^ < assigning authority (HD) > ^ <identifier type code (IS)> ^ < assigning facility (HD)
XCN	Extended composite ID number and name	In Version 2.3, use instead of the CN data type. <ID number (ST)> ^ <family name (ST)> ^ <given name (ST)> ^ <middle initial or name (ST)> ^ <suffix (e.g., JR or III) (ST)> ^ <prefix (e.g., DR) (ST)> ^ <degree (e.g., MD) (ST)> ^ <source table (IS)> ^ <assigning authority (HD)> ^ <name type code (ID)> ^ <identifier check digit (ST)> ^ <code identifying the check digit scheme employed (ID)> ^ <identifier type code (IS)> ^ <assigning facility (HD)>
<b>Generic</b>		
CM	Composite	No new CM's are allowed after HL7 Version 2.2. Hence there are no new CM's in Version 2.3.

**Table 23. Data type descriptions**

Data type	Definition	Data format attributes and notes
<b>Demographics</b>		
AD	Address	<street address (ST)> ^ < other designation (ST)> ^ <city (ST)> ^ <state or province (ST)> ^ <zip or postal code (ST)> ^ <country (ID)> ^ <address type (ID)> ^ <other geographic designation (ST)>
PN	Person name	<family name (ST)> ^ <given name (ST)> ^ <middle initial or name (ST)> ^ <suffix (e.g., JR or III) (ST)> ^ <prefix (e.g., DR) (ST)> ^ <degree (e.g., MD) (ST)>
TN	Telephone number	[NN] [(999)]999-9999[X99999][B99999][C any text]
XAD	Extended address	In Version 2.3, replaces the AD data type. <street address (ST)> ^ <other designation (ST)> ^ <city (ST)> ^ <state or province (ST)> ^ <zip or postal code (ST)> ^ <country (ID)> ^ < address type (ID)> ^ <other geographic designation (ST)> ^ <county/parish code (IS)> ^ <census tract (IS)>
XPN	Extended person name	In Version 2.3, replaces the PN data type. <family name (ST)> ^ <given name (ST)> ^ <middle initial or name (ST)> ^ <suffix (e.g., JR or III) (ST)> ^ <prefix (e.g., DR) (ST)> ^ <degree (e.g., MD) (ST)> ^ <name type code (ID) >
XON	Extended composite name and ID number for organizations	<organization name (ST)> ^ <organization name type code (IS)> ^ <ID number (NM)> ^ <check digit (NM)> ^ <code identifying the check digit scheme employed (ID)> ^ <assigning authority (HD)> ^ <identifier type code (IS)> ^ <assigning facility ID (HD)>
XTN	Extended telecommunications number	In Version 2.3, replaces the TN data type. [NNN] [(999)]999-9999 [X99999] [B99999] [C any text] ^ <telecommunication use code (ID)> ^ <telecommunication equipment type (ID)> ^ <email address (ST)> ^ <country code (NM)> ^ <area/city code (NM)> ^ <phone number (NM)> ^ <extension (NM)> ^ <any text (ST)>

**Table 23. Data type descriptions**

Data type	Definition	Data format attributes and notes
<b>Specialty</b>		
<b>Waveform</b>		
CD	Channel definition	<channel identifier (*)> ^ <channel number (NM)> & <channel name (ST)>> ^ <electrode names (*)> ^ <channel sensitivity/units (*)> ^ <calibration parameters (*)> ^ <sampling frequency (NM)> ^ <minimum/maximum data values (*)>
MA	Multiplexed array	<sample 1 from channel 1 (NM)> ^ <sample 1 from channel 2 (NM)> ^ <sample 1 from channel 3 (NM)> ...~<sample 2 from channel 1 (NM)> ^ <sample 2 from channel 2 (NM)> ^ <sample 2 from channel 3 (NM)> ...~
NA	Numeric array	<value1 (NM)> ^ <value2 (NM)> ^ <value3 (NM)> ^ <value4 (NM)> ^ ...
ED	Encapsulated data	Supports ASCII MIMEncoding of binary data. <source application (HD)> ^ <main type of data (ID)> ^ <data subtype (ID)> ^ <encoding (ID)> ^ <data (ST)>
<b>Price data</b>		
CP	Composite price	In Version 2.3, replaces the MO data type. <price (MO)> ^ <price type (ID)> ^ <from value (NM)> ^ <to value (NM)> ^ <range units (CE)> ^ <range type (ID)>
<b>Patient administration/Financial information</b>		
FC	Financial class	<financial class (ID)> ^ <effective date (TS)>
<b>Extended queries</b>		
QSC	Query selection criteria	<name of field (ST)> ^ <relational operator (ID)> ^ <value (ST)> ^ <relational conjunction (ID)>
QIP	Query input parameter list	<field name (ST)> ^ <value1 (ST) & value2 (ST) & value3 (ST) ...>
RCD	Row column definition	<HL7 item number (ST)> ^ <HL7 data type (ST)> ^ <maximum column width (NM)>

**Table 23. Data type descriptions**

<b>Data type</b>	<b>Definition</b>	<b>Data format attributes and notes</b>
<b>Master files</b>		
DLN	Driver's license number	<license number (ST)> ^ <issuing state, province, country (IS)> ^ <expiration date (DT)
JCC	Job code/class	<job code (IS)> ^ <job class (IS)>
VH	Visiting hours	<start day range (ID)> ^ <end day range (ID)> ^ <start hour range (TM)> ^ <end hour range (TM)>
<b>Medical records/Information management</b>		
PPN	Performing person time stamp	<ID number (ST)> ^ <family name (ST)> ^ <given name (ST)> ^ <middle initial or name (ST)> ^ <suffix (e.g., JR or III) (ST)> ^ <prefix (e.g., DR) (ST)> ^ <degree (e.g., MD) (ST)> ^ <source table (IS)> ^ <assigning authority (HD)> ^ <name type code(ID)> ^ <identifier check digit (ST)> ^ <code identifying the check digit scheme employed (ID )> ^ <identifier type code (IS)> ^ <assigning facility (HD)> ^ < date/time action performed (TS)>
<b>Time series</b>		
DR	Date/time range	<range start date/time (TS)> ^ <range end date/time (TS)>
RI	Repeat interval	<repeat pattern (IS)> ^ <explicit time interval (ST)>
SCV	Scheduling class value pair	<parameter class (IS)> ^ <parameter value (IS)>
TQ	Timing/Quantity	<quantity (CQ)> ^ <interval (*)> ^ <duration (*)> ^ <start date/time (TS)> ^ <end date/time (TS)> ^ <priority (ID)> ^ <condition (ST)> ^ <text (TX)> ^ <conjunction (ID)> ^ <order sequencing (*)>

## Examples of ADT messages

WACS returns acknowledgements for accepted messages and error messages for non-accepted messages.

### Acceptable ADT/ACK message and acknowledgement

The following is an example of an A03 message and acknowledgement in HL7 version 2.3 formats.

#### **ADT^A03 message:**

```
<Wed Jan 14 19:34:20 2009>      HL7Log Responder got message:
MSH|^~\&|REG|RMH||RMH|20090114193305.00000600||ADT^A03|2271605|P|2.3EVN|03|20090114
193305.0000-0600||AKM1^UNREAL^STEWART
PID||2006275669|2006275669||SAMPLE^MELISSA^T||19600915193300.00000600|F|||||||2006276
69
PV1||E|ER|1|||5002^EXAMPLE^KEVIN^P|||ER|||7|||5002^EXAMPLE^KEVIN^P|ER|1064398|WC|||||||
N|||||01|||||D|||20090114182049.0000-0600|20090114185400.0000-0600
```

#### **ACK acknowledgement:**

```
<Wed Jan 14 19:34:20 2009>      HL7Log Responder sending message:
MSH|^~\&|WAP^WAP||||20090114193420.3160600||ACK^A03|20090114193420316e9|P|2.3
MSA|AA|2271605
```



## Unacceptable ADT messages and WACS error messages

WACS returns error messages to the CIS/HIS ADT server in response to these messages:

- Message types other than A01, A03, A04, A05, A08, A011 or A13, and your system has not been programmed to block messages other than these.
- HL7 messages containing noncompliant format. In these cases, WACS rejects the entire content of the message.

WACS error message: non-accepted message type

### WACS error message:

```
MSH|^~\&||||20090203130308.435-0500||ACK|16249|P|2.4
MSA|AR|613958749|No appropriate destination could be found to which this message could be
routed.
ERR|^^^207&Application Internal Error&HL70357
```

ADT/ACK error message: noncompliant format

**Note** The Acuity System accepts middle initial only (not middle name) in messages.

In this example, the telephone number (highlighted below in bold text) is a noncompliant format.

### ADT^A01 message:

```
MSH|^~\&|AccMgr|1|||20090130160820||ADT^A03|6139110482|P|2.3.1EVN|A03|20090130160819
PID|1|841940^^^AccMgr^PN|500138979^^^AccMgr^MR^1||SAMPLE^PATIENT^L||19920722|F|T
EST TEST|W|2001 SAMPLE
RD^^SAMPLE^NY^132110000^^M|31|8005551212||E|S|NO|6943809^^^AccMgr^VN^1|099809
553|||2|USA|||NOT A VETERAN|||N
PV1|1|O|2E^237^02^1|3||2E^237^02|1370^TEST^TEST^^^^^^AccMgr^^^^^C|1370^ TEST ^
TEST ^^^^^^AccMgr^^^^^C||TWM|||1||1370^
WESTPFAL^EDITH^^^^^^AccMgr^^^^^C|67|6943809^^^AccMgr^VN^1|200^TEST|1|1||
1||P||20081008111700|20081009180000|3083.9|3083.9|||0
PV2||SOB^NO|||20081008111700
```

### WACS error message:

```
MSH|^~\&||||20090130160831.875-0500||ACK|5804|P|2.4
MSA|AE|6139110482|The phone number component must be supplied and should be in the
following format [999-9999].
ERR|^^^207&Application Internal Error&HL70357
```

## Reconfiguration of ADT services

If your WACS system receives inbound ADT messages from your CIS, and you need to reconfigure certain ADT service settings, such as the CIS server IP address or the CIS server port number, please contact Welch Allyn Technical Services (see “[Contact information](#)” on page 57).

A Technical Service representative can help you access ADT settings in the WACS program’s HL7 - General Settings page (shown below), which is beneath the WACS HL7 Manager tab. ADT settings in this page are only visible to Welch Allyn personnel.

You can access the WACS program via certain internet browsers on any computer in your facility’s intranet. For instructions on accessing the WACS HL7 Manager pages, see the *Welch Allyn Connectivity Server (WACS) Directions for Use*.

**Note** If Welch Allyn personnel assist you in accessing certain ADT settings, do not change ADT settings beyond those with which you are assisted. Changing other ADT settings can render the WACS system inoperable.

The screenshot displays the 'HL7 - General Settings' page in the WACS interface. The page title is 'HL7 - General Settings' and it includes a subtitle: 'Configure the HL7 general settings. For more information on default ranges for any variable, simply click the entry in the table below.' There are 'Save Changes' and 'Reset' buttons. The table below lists various settings:

Description	Default Value	Current Value	New Value
ADT Server IP Address. ADT_SERVER_IP	adt_server	adt_server	adt_server
ADT Server Port Number. ADT_SERVER_PORT	5600	5601	5601
Allow Location IDs to be used for queries and responses LOCATION_BASED	<input type="checkbox"/>	<input type="checkbox"/>	<input type="checkbox"/>
Allow multiple observations for a patient in one HL7 message MULTIPLE_OBSERVATIONS_PER_PATIENT	<input checked="" type="checkbox"/>	<input checked="" type="checkbox"/>	<input checked="" type="checkbox"/>
Allow observations for multiple patients in one HL7 message MULTIPLE_PATIENT_PER_HL7_MESSAGE	<input checked="" type="checkbox"/>	<input checked="" type="checkbox"/>	<input checked="" type="checkbox"/>
Enable HL7 ADT message. (Listen Mode) ADT_ALLOWED	<input checked="" type="checkbox"/>	<input type="checkbox"/>	<input type="checkbox"/>
Enable HL7 message push PUSH_ALLOWED	<input checked="" type="checkbox"/>	<input checked="" type="checkbox"/>	<input checked="" type="checkbox"/>
HL7 Server HL7_SERVER	localhost	localhost	localhost
HL7 Version HL7_VERSION	2.4	2.3	2.3
Message Delay (seconds) MESSAGE_DELAY	420	90	90
Number of seconds to be delayed for push event PUSH_DELAY	60	60	60
Number of seconds to be retrieved when a new patient is connected MAX_HISTORY	7200	600	600
Number of times the server will try to send an HL7 message to client before disconnecting MAX_RETRY_OUTPUT	5	2	2
Port Number PORT_NUM	5600	5600	5600

- A. CIS server IP address used for inbound ADT messages to WACS
- B. CIS server port used for inbound ADT messages to WACS
- C. WACS enabled listening for CIS ADT data

# 7

## XML interface

The optional Third-Party Data Stream Interface option provides a means of moving patient identification and patient numeric data between the Acuity Central Station and a facility's information system.

To receive XML messages from WACS, a CIS/HIS opens a TCP/IP socket and listens. When the Welch Allyn Connectivity Server detects an event, it connects to the socket and sends a message.

The interface provides the following parameters:

**Table 24. XML interface parameters**

Parameter	Content	Note
Command	Set Reset	When the alarm starts. When the alarm ends.
SourceID	[Patient ID or Amended ID]	Acuity uses this as the unique patient identifier across the Acuity network.
Sensitivity	Lethal High Parameter	
ApplicationID	Welch Allyn	
Text	[free-format text]	Alarm type. A valid alarm string (e.g., Heart Rate 250).
MessageID	Event ID	For WACS internal use only.
Timestamp	[time of the alarm]	
GuestName	[Full name of the patient]	
GuestPhysicalLocation	[Assigned location of the patient]	Unit and room number.
Parameter	[Model name and serial number of the alarming monitor]	
DestinationList	[Target recipient ID]	Present only if: - Clinician Notifier option is licensed - Event Delivery Mode = Escalation - At least one Primary Respondent assigned

For example:

```
<?xml version="1.0" encoding="UTF-8"?>
<Emergin Version="7.0">
  <Command>Set</Command>
  <SourceID>MRN-0001</SourceID>
  <Sensitivity>Lethal</Sensitivity>
  <ApplicationID name="WelchAllyn"/>
  <Text>Asystole</Text>
  <MessageID>EVENT-001</MessageID>
  <Timestamp>June 4, 2006 14:25:03</Timestamp>
  <GuestName>Jon L. Doe</GuestName>
  <GuestPhysicalLocation>Zone1 101A</GuestPhysicalLocation>
  <Parameters>Propaq 202, DA005491</Parameters>
  <DestinationList>
    <DestinationID>Nurse1</DestinationID>
  </DestinationList>
</Emergin>
```

```
<?xml version="1.0" encoding="UTF-8"?>
<Emergin Version="7.0">
  <Command>Reset</Command>
  <ApplicationID name="WelchAllyn"/>
  <MessageID>EVENT-001</MessageID>
  <DestinationList>
    <DestinationID>Nurse1</DestinationID>
  </DestinationList>
</Emergin>
```

## 8

## Contacts and specifications

---

### Contact information

If you encounter a problem that cannot be corrected by ordinary operating procedures described in this manual, please contact Welch Allyn Technical Services:

Phone (within the U.S.A.):	1-800-289-2501
Phone (worldwide):	+1 503-530-7500, ask for Technical Service
Fax:	+1 503-526-4970
email:	<a href="mailto:solutions@welchallyn.com">solutions@welchallyn.com</a>
Internet:	<a href="http://www.welchallyn.com/support/default.htm">http://www.welchallyn.com/support/default.htm</a>

### Specifications

#### General WACS

**Table 25. WACS 2.6x compatibility**

Acuity System Component	Software version compatible with WACS 2.6x
Acuity Central Monitoring System	8.2x
WACS Web Server option Operating systems/browser combinations supported by WACS	Windows XP (SP 1.2)/Microsoft Internet Explorer 6.x and 7.x, Firefox 2, Firefox 3
WACS AcuityLink Clinician Notifier option	1.4x and later

**Table 26. WACS Hardware**

Rackmount server
Video card: none
Display: none
Ethernet interfaces (IP addresses): multiple; one connected to the Acuity System network, one to the facility network
Wireless LAN: none, no wireless card
Electromagnetic compliance: Refer to the <i>Acuity and Mobile Acuity LT Central Monitoring Systems Directions for Use</i>

## WACS HL7 Interface option

### Outbound messaging

**Table 27. Configuration variables under HL7 tab**

<b>HL7 Manager page</b>	<b>Default setting</b>	<b>Alternate settings</b>
Numeric data filter	Median (can be mean for even number of samples)	Closest (most recent)
Numeric data filter for NIBP	Closest (most recent)	Median (can be mean for even number of samples)
<b>HL7 - General Settings page</b>		
HL7 versions supported	2.4	2.31, 2.3
Allow observations for multiple patients in one HL7 message	Off	On
Number of seconds to be retrieved when a new patient is connected	7200	Field entry allowed
Allow multiple observations for a patient in one HL7 message	Off	On
Number of times the server will try to send an HL7 message to client before disconnecting	5	Field entry allowed
Message delay (seconds) (for push)	420	Field entry allowed
<b>HL7 - Push on Event Settings page</b>		
Each vital sign listed in page	Off	On
<b>HL7 - Observation Identifiers page</b>		
Vital-sign labels	As listed in page	Field entry allowed

**Table 28. Non-supported features**

Simultaneous clients: WACS sends data to only one CIS
HL7 batch processing: WACS only sends data at a regular interval or in response to a query
Wildcards: WACS does not accept wildcards

# Index

---

## A

### ADT

- acceptable messages from 52
- data types accepted from 47
- erroneous messages 52
- HL7 messages 41
- how Acuity System uses information 43
- message formats accepted from 46
- WACS messaging rules 44

## C

- CIS ADT messages 41
- configuring HL7 interface 5

## D

### Data

- interface 6
- transfer and storage in Acuity System 7
- types accepted 47

- Delimiters, accepted HL7 46
- documents, related 3

## E

- Error messages sent by WACS 52

## F

- Formats, accepted HL7 message 46

## H

- Health Level Seven Standard 11
- Help 57
- HL7
  - configuration by qualified personnel 2
  - interface, configuring 5

## I

### ID

- entry sequence 44
  - where entered in system 43
- Inbound HL7 ADT Data module 41
- Interface, data 6

## M

### Message

- ADT error, sent by WACS 52
- ORU/ACK example 29
- QBP^RSP example 39
- QBP/RSP example 35, 37
- QRY/ORF example 32, 36, 38
- time/date example 13
- types and formats received by WACS 46

## O

- Outbound HL7 Vital-sign Observations module 15
- Overview, system 5

## P

### Patient ID

- entry sequence 44
- where entered in system 43

## S

- segment-level protocol, HL7 12
- server 5
- specifications 57

## T

- Technical Service, Welch Allyn 57
- Troubleshooting 57

## V

- Vital-sign Observation module, Outbound HL7 15

## W

### WACS

Help 57

troubleshooting 57

warning 2

Welch Allyn, Technical Service 57

## X

XML interface 55