



FRONTLINE
HOSPITAL CARE

WELCH ALLYN AUSTRALIA
P.O. Box 132, The Metro Centre, Unit 5, 38-46 South Street, Rydalmere, NSW 2116, Australia
(p) +61 2 9638 3000 (f) +61 2 9638 3500 www.welchallyn.com.au

WELCH ALLYN CHINA
Room 1011, Central Plaza, No. 227 Huang-Pi Bei Road, Huang Pu District, Shanghai, China
(p) +86 21 6327 9631 (f) +86 21 6327 9632 www.welchallyn.cn

WELCH ALLYN SINGAPORE
10 Hoe Chiang Road, Keppel Towers #19-03/04, Singapore 089315
(p) +65 6419 8100 (f) +65 6291 5780 www.welchallyn.com.sg

WELCH ALLYN MALAYSIA
10A, Jalan SS 3/33, Taman Universiti, 47300 Petaling Jaya, Selangor, Malaysia
(p) +60 3 7875 3341 (f) +60 3 7875 4210 www.welchallyn.com.my

4341 State Street Road, P.O. Box 220, Skaneateles Falls, NY 13153-0220 USA
(p) 315.685.4100 (f) 315.685.3361 www.welchallyn.com

WelchAllyn[®]
Advancing Frontline Care[™]

WelchAllyn[®]
Advancing Frontline Care[™]

© 2007 Welch Allyn SM2431AP Rev C
Nellcor[®] is a registered trademark of Nellcor Puritan Bennett, Inc. ThermoScan[®] is a registered trademark of Braun GmbH.
Windows[®] is a registered trademark of Microsoft. Masimo[®] is a registered trademark of Masimo Corporation.

Welch Allyn. Advancing Frontline Care

You're on the front lines of patient care every day—evaluating, diagnosing, monitoring, and providing treatment—quickly and accurately, without losing sight of the patient as a person. It's that front line of care where we here at Welch Allyn focus our skills.

As the first name in medical diagnostic instruments, we know your specialised environment better than anyone. The value of time, the need to act quickly, the importance of having absolute confidence in your diagnostic information and the ability to deliver the best care in an increasingly challenging, fast-paced environment.

The result is innovation that puts state-of-the-art technology at the service of Hospital Care, with practical, efficient, reliable, affordable instruments that give you the very best tools for an extremely demanding environment. The front line of care is where what we do best enhances what you do best.

FRONTLINE HOSPITAL CARE

- 1 Fibre Optic Laryngoscope Handle & Blade Pg. 37
- 2 PIC 30™ Monitor/Defibrillator Pg. 27
- 3 Reusable One-Piece Blood Pressure Cuffs Pg. 12
- 4 Vital Signs Monitor 300 Series Pg. 17
- 5 Disposable Blood Pressure Cuffs Pg. 12
- 6 767 Wall Transformer with PanOptic™ Ophthalmoscope and MacroView™ Otoscope Pg. 6
- 7 Propaq® LT Monitor with Large Colour Display Pg. 22
- 8 Harvey™ Elite® Stethoscope Pg. 11
- 9 Braun ThermoScan® PRO 4000 Ear Thermometer Pg. 19
- 10 SureTemp® Plus 692 Electronic Thermometer Pg. 18
- 11 DS58 Classic Aneroid
- 12 KleenSpec® Vaginal Specula Pg. 36
- 13 KleenSpec® Illumination/Storage System Pg. 36
- 14 Spot Vital Signs® LXI Pg. 14

For more information on the products in this catalogue, visit our website at:
www.welchallyn.com
www.welchallyn.com.au (Australia)
www.welchallyn.cn (China)
www.welchallyn.com.my (Malaysia)
www.welchallyn.com.sg (Singapore)



767 Integrated Diagnostic Systems

Otoscope, ophthalmoscope, thermometer, sphygmomanometer, probe covers, eartips—all the essential diagnostic instruments and consumables for every emergency department exam room, integrated for efficiency and convenience.

- Choice of the revolutionary PanOptic™ Ophthalmoscope* or a 3.5 V Coaxial Ophthalmoscope
- MacroView™ Otoscope provides a 30% larger view than traditional otoscopes
- Handle-based rheostats for quick light-intensity adjustments
- 767 Wall Aneroid with easy-to-read dial face, certified accuracy, and lifetime calibration program
- KleenSpec® Plus Disposable Specula Dispenser, prefilled with ear specula
- Locking collar available to deter theft (#76700)
- Optional—SureTemp® Plus Electronic Thermometer for highly accurate oral readings in approximately 4-6 seconds

*For full details on the PanOptic Ophthalmoscope and MacroView Otoscope, see pages 9 and 10. Available in multiple configurations. See International Conversion Codes chart on page 42 for local part numbers.



767 Wall Transformer with Instrument Heads

Accurate diagnostics within easy reach.

- Offers the flexibility to add on as you grow
- Handle-based rheostats for quick light intensity adjustments
- Modular design provides ability to add third handle or SureTemp® Plus 690 thermometer
- OptiSense™ sensor automatically turns handles on and off when removed and replaced from cradle

INSTRUMENT HEADS

- 76715* 767 Wall Transformer with Handles Only
- 11820 PanOptic Ophthalmoscope
- 11720 Coaxial Ophthalmoscope
- 23810 MacroView™ Otoscope
- 25020 Diagnostic Otoscope
- 20000 Diagnostic Otoscope with Throat Illuminator

*Available in multiple configurations. See International Conversion Codes chart on page 42 for local part numbers.

ACCESSORIES

- 7670-01 767 Wall Aneroid Sphygmomanometer
- 52401 KleenSpec® Plus Ear Specula Dispenser
- 01690-500 SureTemp Plus 690 Thermometer, 2.7 m Oral Probe with Probe Well and Wall Holder

“We purchased the Welch Allyn Integrated Diagnostic System for all our new health care centre exam rooms and have been extremely pleased. They’ve added to our efficiency.”

— PAUL LOISELLE,
EXECUTIVE DIRECTOR, HEALTH CARE,
UNIVERSITY OF NEW ENGLAND



Universal Desk Charger Set

Keep your diagnostic instruments powered up and ready to go with our most popular handles and instruments in one easy-to-order set.

- Coloured LEDs signal power is “on” and instruments are charging
- Advanced circuitry ensures constant, safe charging and optimum, long-lasting lamp life
- Optional specula tray available

71145*
Universal Desk Charger with PanOptic™ Ophthalmoscope (11820), Diagnostic Otoscope (20000) and (2) Lithium Ion handles

See page 9 for full details on the PanOptic Ophthalmoscope, and page 10 for the Diagnostic Otoscope.

*Available in multiple configurations. See International Conversion Codes chart on page 42 for local part numbers.



71715*
Desk Charger with Ophthalmoscope (11720), Otoscope (25020) and NiCad Handles



92821

2.5 V PocketScope™ Set

In the office or out, you'll always have the accuracy and convenience of Welch Allyn diagnostics right in your pocket.

- 2.5 V PocketScope ophthalmoscope with consistent, long-lasting halogen illumination for true tissue colour
- 2.5 V PocketScope otoscope with built-in throat illuminator gives you two instruments in one, with halogen illumination and fibre optics for cool light
- Adjustable rheostat to control light intensity
- Powered by AA batteries
- Available in either hard or soft case

92820 PocketScope Set with Hard Case

92821 PocketScope Set with Soft Case

3.5 V Diagnostic Set

Keep your diagnostic instruments together and easily portable, with our most popular handle and instruments in one easy-to-order set.

- Choice of the PanOptic™ Ophthalmoscope or 3.5 V Coaxial Ophthalmoscope
- Choice of the MacroView™ Otoscope or 3.5 V Diagnostic Otoscope
- Lithium Ion rechargeable handle provides longer operation time between charges (120 minutes compared to 60 minutes for standard NiCad handles)
- Comes complete with a zippered, hard case for secure storage and easy portability

Available in multiple configurations. Please contact your Welch Allyn representative to customise your 3.5 V Diagnostic Set.



3.5 V set with PanOptic Ophthalmoscope, MacroView Otoscope and Lithium Ion Handle

3.5 V Lithium Ion Rechargeable Handle

Twice the power, half the weight.

- Smaller diameter and half the weight of 3.5 V NiCad handles
- 120 minutes of operation between charges (compared to 60 minutes for standard NiCad handles)
- Charges in Universal Desk Charger or pod charger
- Compatible with all Welch Allyn 3.5 V instrument heads
- Low battery indicator light

71910 Handle Only

71905* Li-Ion Handle with Pod and Charger

*See International Conversion Codes chart on page 42 for local part numbers.



71905



11720

3.5 V Standard Coaxial Ophthalmoscope

- Halogen HPX™ lamp provides 30% whiter, brighter light than traditional ophthalmoscopes for true tissue colour and long performance
- Detect corneal abrasions and foreign bodies with cobalt blue filter
- Coaxial optical system produces shadow-free spot viewing
- Polarising filter virtually eliminates corneal reflection
- Sealed optics keep out dust and dirt

11720 3.5 V Coaxial Ophthalmoscope (Head Only)

PanOptic™ Ophthalmoscope

The revolutionary PanOptic provides easier entry into the eye, together with a dramatically wider field of view to more easily evaluate head trauma, papilledema and retinal hemorrhage.

- Fast entry into undilated pupils
- 5 x larger view of the fundus vs. standard scopes in an undilated eye
- 25° field of view vs. the standard 5° field of view
- Greater working distance improves comfort for both practitioner and patient
- Detect corneal abrasions with cobalt blue filter and corneal viewing lens
- Compatible with all existing Welch Allyn 3.5 V power sources

11820 PanOptic Ophthalmoscope with Cobalt-Blue Filter and Add-On Corneal Viewing Lens (Head Only)



11820

“PanOptic's breadth of the field of view gives me a much greater visual appreciation of retinal structures. It increases my confidence during an exam.”

— LARRY CULPEPPER, MD

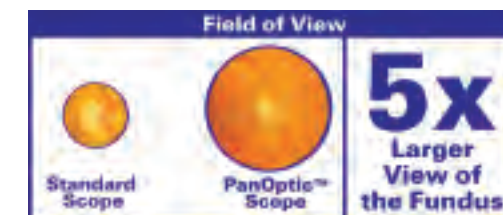

3.5 V MacroView™ Otoscope

The MacroView Otoscope offers a significant advance in hand-held otoscopy, providing the practitioner with an improved view for enhanced decision making.

- Enables nearly a full view of the tympanic membrane with 30% more magnification than tradition otoscopes
- Focusable eyepiece
- Tip grip for more secure speculum attachment
- Halogen HPX™ lamp provides bright, white light output for true tissue colour and long-lasting performance
- Fibre optics project cool light to the distal tip with no reflections or obstructions, for clear viewing of the tympanic membrane
- Sealed system allows for pneumatic otoscopy and accurate diagnosis of otitis media



- 23820 3.5 V MacroView Otoscope with Throat Illuminator (Head Only)
- 23810 3.5 V MacroView Otoscope (Head Only)
- 23804 Insufflation Bulb for MacroView Otoscope
- 24320 SofSeal Single Use Sealing Tip, Small (80/Box—6 Boxes/Case)
- 24330 SofSeal Single Use Sealing Tip, Medium (80/Box—6 Boxes/Case)
- 52700 Disposable Instrumentation Tip for MacroView (48/Box—4 Boxes/Case)



3.5 V Bivalve Nasal Illuminator

For a clear, true view of the nasal cavity.

- Halogen HPX™ lamp provides bright, white light for true tissue colour and long-lasting performance
- Adjustable speculum facilitates removal of foreign bodies
- Compatible with all existing Welch Allyn 3.5 V power sources

26030 3.5 V Bivalve Nasal Illuminator (Head Only)



3.5 V Diagnostic Otoscope

Durable, general-purpose otoscopes.

- Halogen HPX™ Lamp provides bright, white light output for true tissue colour and long-lasting performance
- Fibre optics project cool light to the distal tip with no reflections or obstructions, for clear viewing of the tympanic membrane
- Sealed system allows for pneumatic otoscopy and accurate diagnosis of otitis media
- Simply detach the head for high-intensity throat illumination or all-purpose penlight (model 20000 only)

20000 3.5 V Diagnostic Otoscope with Throat Illuminator (Head Only)
25020 3.5 V Diagnostic Otoscope (Head Only)

5079-125



Harvey™ Elite® Stethoscope

- High-quality stainless steel chestpiece and binaurals designed for durability
- Superior performance throughout the entire acoustic range
- Dual-channel PVC tubing provides separate sound pathways to each ear for unrivaled accuracy
- Comes standard with paediatric diaphragm

5079-125S Harvey Elite® Stethoscope shown in black, also available in burgundy, navy and green
5079-232 Accessory Kit (Includes paediatric chestpiece, extra adult diaphragm, extra ear tips)



Elite Electronic Sensor-Based Stethoscope System

Hear more clearly, with unmatched purity of sound, thanks to patented SensorTech™ technology.

- Innovative technology reproduces biological sounds with exceptional sound quality, even through clothes and thick, fatty tissue
- Allows for easy detection of soft murmurs
- Optional—the Distributor allows colleagues and students to hear simultaneously, and the Analyser PC-based software allows for recording, analysis, and distribution of image-based sound files for review and comparison

5079-405 Elite Electronic Stethoscope
5079-401 Elite Electronic Distributor
5079-430 Elite Electronic Analyser Software with ECG



Professional Stethoscope

Comfortable, lightweight, affordable.

5079-135 Single Lumen Professional Stethoscope (Adult, Double-Head)
5079-145 Single Lumen Professional Stethoscope (Paediatric, Double-Head)
Shown in black. Also available in burgundy, navy and green.

Tycos® 767-Series Wall and Mobile Aneroids

Great looks and clinical-grade accuracy make the 767-Series one of the best Tycos aneroids ever.

- Certified accuracy to ±3 mmHg
- Mercury-free and latex-free for safety
- Ruby-jeweled movement for long life
- Laser-engraved dial face for accuracy
- Large, easy-to-read dial face (6.25" / 15 cm)
- Built-in cuff storage
- Adjustable height and 360° swivel for clear viewing (mobile only)
- Lifetime warranty on calibration

7670-01 Wall Aneroid with Durable One-Piece Adult Cuff

7670-03 Mobile Aneroid with Four-Leg Mobile Stand and Durable One-Piece Adult Cuff

7670-04 Mobile Aneroid with Four-Leg Mobile Stand with Base Weight and Durable One-Piece Adult Cuff

7670-10 Mobile Aneroid with Sturdy Five-Leg Mobile Stand and Durable One-Piece Adult Cuff

7670-11 Mobile Aneroid with Sturdy Five-Leg Mobile Stand with Base Weight and Durable One-Piece Adult Cuff



7670-01



Reusable One-Piece Cuffs and Inflation Systems

Never remove, clean or replace a bladder.

- Made of strong 70-denier nylon—50% lighter and stronger than traditional cuff-and-bladder combinations
- Available in one- and two-tube designs for electronic NIBP monitors and sphygmomanometers
- Convenient one-piece design delivers dependable, accurate results
- Range/index markings on outside of cuff make it easy to size the correct cuff for each patient
- Antimicrobial-treated to help resist the growth of mildew and bacteria
- Latex-free for safety
- Connectors attached to fit virtually every brand of NIBP monitors

Disposable One-Piece Cuffs and Inflation Systems

Prevent cross-contamination in high-risk areas.

- Soft or vinyl cuffs are durable and latex-free
- Available in one- and two-tube designs for electronic NIBP monitors and sphygmomanometers
- Convenient one-piece design delivers dependable, accurate results
- Range/index markings on outside of cuff make it easy to size the correct cuff for each patient
- Colour-coded for easy size identification (soft style only)
- Flat port tubing connectors help keep tubes out of the way—particularly important for neonatal applications
- Connectors attached to fit virtually every brand of NIBP monitors

For a complete listing of cuffs and order numbers, please contact your Welch Allyn representative.

DuraShock™ Model DS66 Gold Range Trigger Aneroid

Innovative trigger-release design for easy operation.

- Certified accuracy to ±3 mmHg
- Meets AAMI shock-resistant standard for enhanced durability (30")
- Laser-engraved dial face for accuracy
- Jeweled movement for long life
- Trigger deflation valve for smooth, one-finger operation
- Latex-free for safety
- 15-year calibration warranty
- Comes complete with case

5098-27 DuraShock DS66 with durable one-piece adult cuff, single tube, black, and zipper case



5098-27

DuraShock™ Model DS65 Silver Range Integrated Aneroid

- Certified accuracy to ±3 mmHg
- Meets AAMI shock-resistant standard for enhanced durability (30")
- Trigger air release valve
- Shock-resistant for accuracy and lower cost over time
- Laser-engraved dial face for accuracy
- Premium aesthetics
- 10-year calibration warranty
- Comes complete with case

DS65-01-189 DuraShock DS65 with durable one-piece adult Velcro cuff and zipper case, single tube, black



DS65-01-189

DuraShock™ Model DS44 Bronze Range Integrated Aneroid

- Shock resistant for accuracy and lower cost over time
- About half the weight of a traditional sphygmomanometer
- Gauge snaps directly into the cuff for fast and easy cuff change
- 5-year calibration warranty on accuracy of gauge
- Complete with case

DS44-11V DuraShock DS44 with durable one-piece adult Velcro cuff and zipper case

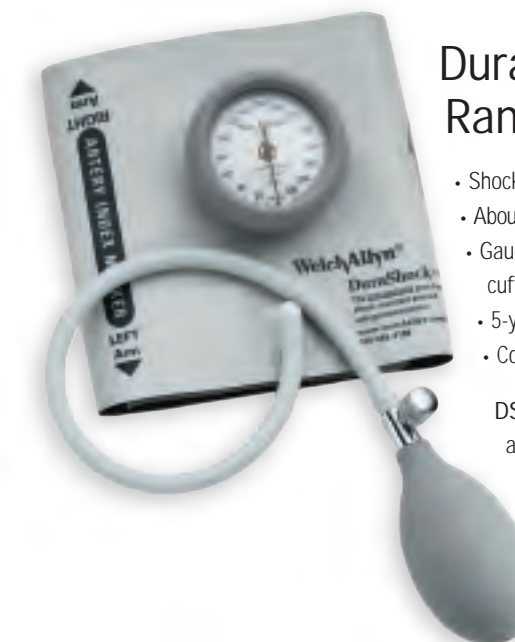

Welch Allyn blood pressure products featuring DuraShock technology are the only gauges with a shock-resistant, gear-free design. The unique design allows increased shock resistance, providing additional durability and requiring calibration less often than many competing gauges. The end result? Welch Allyn blood pressure gauges maintain accurate readings longer than competing gauges, costing you less over time. Learn more at www.welchallyn.com/durashock.

Vital Signs Measurement



MORE FUNCTIONALITY—YET AMAZINGLY SIMPLE TO USE.

Spot Vital Signs® LXi



Take vital signs in about half the time.
Take patient care to a whole new level.

In today's demanding healthcare environment you don't have time to search for multiple pieces of vital signs equipment or to learn how to navigate complex instruments. You need a simple and flexible vital signs device that can capture the data you need faster, easier, and more reliably. The new Welch Allyn Spot Vital Signs LXi provides more parameters and options than any other spot-check device on the market. It features the latest technology to help you gather more measurements faster, giving you more time to spend with your patients.



“We love the convenience. Being able to automatically collect all the vital signs in a short amount of time really frees up the nurses.”

— LAURIE MCGRAW, RN

Spot Vital Signs® LXi

Check blood pressure faster. Take temperatures using the method you prefer. Measure SpO₂ with the technology you want. The Spot Vital Signs LXi is a faster, smarter, more efficient way to take vital signs.

- SureBP™ measures blood pressure in about 15 seconds as the cuff is inflating—resulting in time savings for you and improved comfort for your patients. Pulse rate and MAP included
- Choice of SureTemp® Plus thermometer or Braun ThermoScan® PRO 4000 ear thermometer
- Choice of Masimo® or Nellcor® pulse oximetry
- Ability to manually enter weight, height, respiration rate, and pain level; calculates Body Mass Index
- Connects to select Health o meter® or Tanita® digital scales
- 50-reading memory allows retrieval of previous data for review or to download later
- Comes connectivity-ready, allowing you to connect to the electronic medical record system you have now or one you'll get in the future
- Bigger, brighter LCD display provides greater visibility from farther distances

*Available in multiple configurations. See International Conversion Codes chart on page 43 for local part numbers.



45MT0

Vital Signs Monitor 300 Series

For simple and accurate spot-check vital signs assessment or continuous monitoring, the Vital Signs Monitor 300 Series is the definition of “advanced monitoring made affordable.”

- Standard noninvasive blood pressure (NIBP), pulse rate and mean arterial pressure (MAP)
- Optional—SureTemp®* Plus thermometry, motion tolerant Masimo® or Nellcor® pulse oximetry and integrated thermal printer
- Supports adult, paediatric and neonatal patients
- Simple to use—new LCD display facilitates menu navigation
- Includes automatic blood pressure mode, programmable alarms, built-in memory and intuitive icons
- Lightweight and portable, with a variety of mounting options

*See page 18 for full details on Welch Allyn SureTemp Plus thermometry.

*Available in multiple configurations. See International Conversion Codes chart on page 43 for local part numbers.



53NTP

Spot Vital Signs®

Take vital signs in seconds with hospital-grade technology that spot checks vital signs easily, accurately and affordably.

- Automated measurement of noninvasive blood pressure (NIBP), pulse rate, temperature and pulse oximetry in 30 seconds
- Flexible configurations yet fully upgradeable to meet your future needs
- Lightweight and portable with a variety of mounting options
- All configurations include NIBP, pulse rate and mean arterial pressure (MAP)
- Optional—SureTemp® thermometry, Masimo® or Nellcor® pulse oximetry

Available in multiple configurations. See International Conversion Codes chart on page 43 for local part numbers.



42MTB-E1



42NTB AND 4200-60

To meet the needs of a busy emergency department, Welch Allyn offers you all the modalities for temperature-taking, for all types of patients.



SureTemp® Plus Thermometers

Perfect for your triage and exam rooms, Welch Allyn's SureTemp Plus thermometers combine the speed of ear thermometry with the accuracy and reliability of traditional oral thermometry. You can take approximately 4- to 6-second oral, 10-second paediatric axillary, 15-second adult axillary and 10-second rectal temperatures.

- Ergonomic design—comfortable to hold, easy to use, and very durable
- Interchangeable, removable probe wells to reduce the risk of cross-contamination
- Large backlit LCD display (692 only)
- Your choice of security alarm systems to help prevent theft (692 only)
- Takes approximately 5000 readings on 3 AA batteries



01692-400

- 01692-400 SureTemp Plus 692 Thermometer, Oral Probe with Oral Probe Well, Wall Mount and Security System
- 01690-410 SureTemp Plus 690 Thermometer, Oral Probe with Oral Probe Well
- 02892-000 Rectal Probe and Well Kit (1.2 m)
- 02893-000 Oral Probe and Well Kit (1.2 m)
- 05031-101 Probe Covers (box of 1,000)
- 08273-000 Mobile Stand
- 21326-0000 Wall Holder



08273-000



01690-410



04000-200

BRAUN *ThermoScan* PRO 4000 Ear Thermometer

The Braun ThermoScan PRO 4000 Ear Thermometer gives you the speed and accuracy you need with all of your patients. The exclusive ExacTemp™ technology provides an active user feedback system to ensure proper positioning and improved accuracy.

- Improved accuracy and repeatability through a preheated probe tip and sensor
- Probe cover detection system ensures precise infrared heat transfer for accurate temperatures
- Automatic probe cover eject button for quick and easy disposal of used probe covers
- Easy-to-read LCD displays temperatures in Celsius or Fahrenheit
- Two-year limited warranty

- 04000-200 Braun ThermoScan PRO 4000
- 05075-800 Probe Covers (case of 800)



Patient Monitoring



FLEXIBLE MONITORING—THE FREEDOM TO MONITOR PATIENTS ANYTIME, ANYWHERE



Reduce transfers, diverts and backups by making any bed a monitored bed in seconds.

Provide continuous vital signs monitoring anywhere in your facility—and improve patient flow—with Flexible Monitoring, Welch Allyn's affordable, state-of-the-art monitoring solution. By converting any bed into a monitored bed, Flexible Monitoring lets you monitor more patients in more places and reduce the number of transfers, diverts, and backups—shortening lengths of stay, increasing patient throughput, and enhancing clinical productivity. Flexible Monitoring helps you manage your time and resources—helping you provide more efficient and effective care for your patients.



The Welch Allyn Propaq® LT

It won't just change how you monitor patients. It'll change where you do it.



The Propaq LT can be custom-configured for your care area and weighs less than a kilogram, making it perfect as both a bedside and ambulatory monitor. It connects to a large colour display panel for easy viewing during bedside procedures.

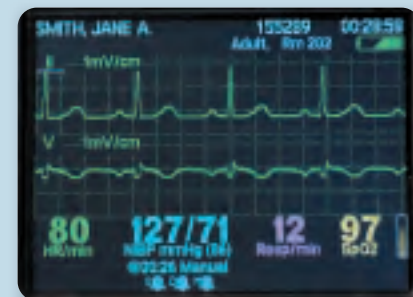

Time	HR/min	NIBP avg (mmHg)	Resp/min	SpO2
12:30	80	n/a	12	97
12:29	80	n/a	12	97
12:28	80	n/a	12	97
12:27	80	n/a	12	97
12:26	80	127/71 (86)	12	97
12:25	80	n/a	12	97
12:24	80	122/72 (86)	12	97

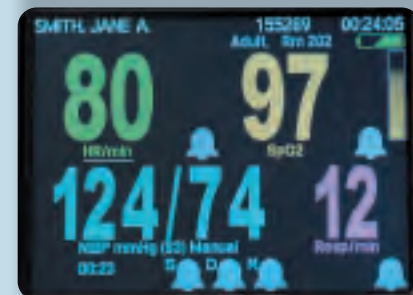

Easily navigate between spot-check, tabular trend, and multiwaveform screens to get information customised to your unique needs.



PROPAQ® LT

Monitor more patients in more places with the Propaq LT. Designed for bedside procedures, ambulatory monitoring and transport applications, it is ideal for busy hospital settings.

- Legendary quality and durability
- Can withstand being dropped from distances of up to 1.82 m
- Heart rate, 3- or 5-lead ECG, SpO₂, NIBP, respiration
- Neonatal, paediatric and adult modes
- Continuous monitoring and spot-check modes
- Wireless connectivity to Acuity® Central Station

Product models and configurations vary by country. Contact your Welch Allyn representative for more information.

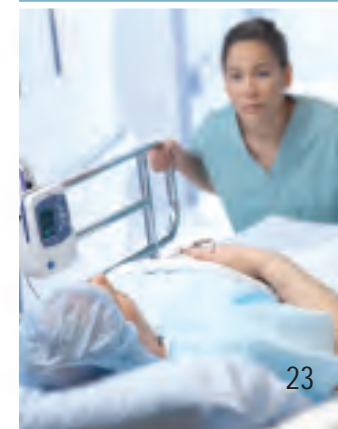



Acuity® Central Station

The power to monitor as many as 60 patients per unit from one central location on a simple, easy-to-use interface. View real-time patient data, up to 96 hours of full disclosure waveforms, and ST and arrhythmia event information—and have the capability to monitor patients from just about anywhere or any place in your facility.

- Customised map of care unit shows each patient's status and assigned location
- Control of both wireless and hardwired patient monitors from one central station
- Adjustable alarms at patient monitor or central station
- Bidirectional communication with Welch Allyn patient monitors



01031633

Propaq® CS

Small, light, and rugged, it's the perfect instrument for continuous vital signs monitoring.

- Large colour display may be read across the room with colour-differentiated parameters
- Custom selection of up to four viewable waveforms
- Adult, paediatric, and neonatal modes for customised monitoring of specific patient populations
- Optional wireless connectivity to the Acuity® Central Station allows truly flexible monitoring
- Optional mainstream and/or sidestream CO₂ monitoring
- Two-year warranty

Propaq Encore®

Rugged enough for the fast-paced monitoring demands of emergency departments and medical transport.

- Long battery life protects against data loss during transport and procedures
- Smartcuf® NIBP for accurate, consistent readings in challenging environments
- Adult, paediatric, and neonatal modes for customised monitoring of specific patient populations
- Masimo® or Nellcor® SpO₂ provides accurate readings during motion or low perfusion, resulting in fewer alarms and quicker readings
- Optional mainstream and/or sidestream CO₂ monitoring
- Optional one or two invasive blood pressure lines
- Hardwired connectivity to Acuity® Central Station
- Two-year warranty



01020823



01080006

Micropaq®

The convenience and efficiency of a patient monitor that's wireless and wearable. Ideal for monitoring vital signs of higher-acuity overflow patients, ambulating patients and administering medications at the bedside.

- Displays heart rate, one or two ECG leads, SpO₂ numerics and pulse bar
- Continues monitoring even when out of telemetry range
- Up to 25-hour battery life when fully charged
- Connects wirelessly to Welch Allyn's Acuity and Acuity LT Central Monitoring Stations

Multiple configurations available. Contact your local Welch Allyn representative for more information.



AED 20™ Automated External Defibrillator

The unique, simple-to-operate AED 20 provides basic AED function with optional Lead II monitoring.

- Choice of rechargeable battery for frequent users or a long-life nonrechargeable battery for infrequent rescuers
- Optional ECG monitoring and optional passcode-protected manual defibrillation
- Data card transfer of critical patient data and direct connect printing to PCL5 printers provide efficient management of data
- Conforms to G2005 Guidelines

Multiple configurations available. Contact your local Welch Allyn representative for more information.



AED 10™ Automated External Defibrillator

Designed for easy operation and quick deployment by the infrequent user, the AED 10 uses the simple "1-2-3" approach—a proven rescue protocol used throughout the world.

- Text and voice instructions guide the user through the rescue. Colour-coded pads and illustrations ensure proper pad placement
- High-performance battery delivers five years of standby performance or over 90 discharges at 360 J
- Internal memory stores event data including ECG waveforms, time/date stamps, shock delivery and system actions
- Compatible with major manufacturer defibrillator pads
- Conforms to G2005 Guidelines

Multiple configurations available. Contact your local Welch Allyn representative for more information.

PIC 50™

Designed for high-acuity settings, the PIC 50 boasts multiparameter monitoring and defibrillation capabilities in one compact, lightweight and durable package.

- 3- or 5-lead ECG monitoring, multiparameter defibrillator, recorder and SpO₂
- Optional full diagnostic 12-lead ECG with interpretation, AED, EtCO₂, noninvasive blood pressure, two invasive blood pressure lines, external pacing, and temperature, all in a single 4.5 kg box
- Large colour display with colour-coded parameters that can be viewed from virtually any angle
- NiMH battery delivers more than four hours of continuous performance from a single charge
- Power options and battery support systems available to meet virtually any need
- Optional data card transfer, fax and GSM cellular

Multiple configurations available. Contact your local Welch Allyn representative for more information.

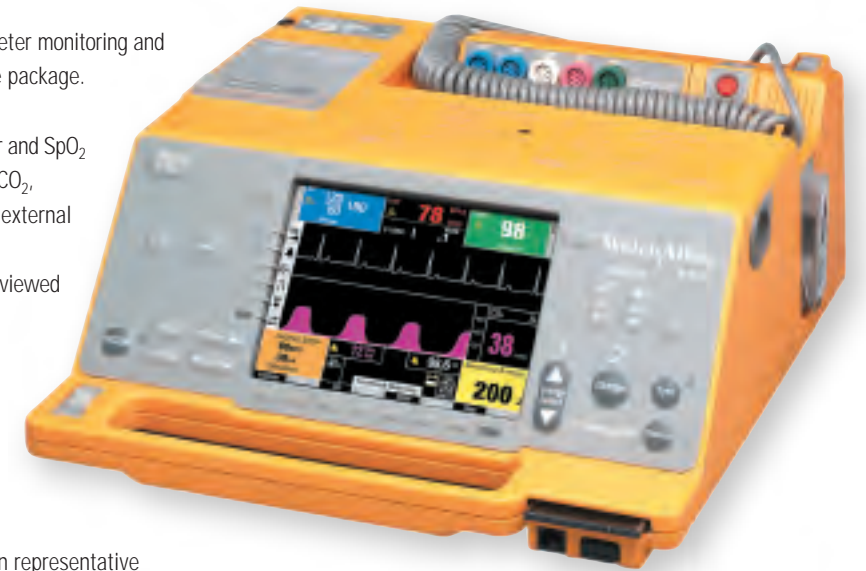

PIC 40™

A multiparameter monitor, AED, and defibrillator with external pacing, the PIC 40 is the perfect solution for ambulatory surgery.

- Radiant colour display provides waveforms, patient data and defibrillation functions that can be viewed from virtually any angle
- 3- or 5-lead ECG and SpO₂
- Optional parameters include NIBP and external pacing
- Manual defibrillator provides full range of energy settings (2 J to 360 J)
- AED is configurable

Multiple configurations available. Contact your local Welch Allyn representative for more information.



PIC 30™

Designed for the crashcart and other manual defibrillation environments, the PIC 30 monitor/defibrillator is the economical choice for your patient care department, clinic or day surgery centre.

- Radiant colour display provides excellent visibility
- Annotating recorder captures all vital data on 50 mm printer
- Full manual defibrillation (2 J to 360 J) and sync capabilities
- Optional external pacing and shock advisory

Multiple configurations available. Contact your local Welch Allyn representative for more information.

Cardiopulmonary



THE MOST FLEXIBLE CONNECTIVITY SOLUTIONS FOR MORE EFFECTIVE, EFFICIENT PATIENT CARE.

Resting ECG Pocket PC ECG PC-based Resting ECG Exercise Stress ECG Spirometry ABPM Holter



Welch Allyn CardioPerfect™ Workstation Software

Powerful software that makes data management easier

Access your patient data across the entire family of cardiopulmonary products with Welch Allyn CardioPerfect™ Workstation Software. Manage data from a variety of different diagnostic tests in the same way and store all of your patient information in a single record, allowing you to retrieve and analyse information quickly, and be more efficient with your patients.



28 Welch Allyn CardioPerfect™ Workstation Software can connect to many leading electronic medical records (EMRs), letting you automate patient records systems and enjoy paperless efficiency.

CP 100™

A reliable, easy-to-use, and cost-effective ECG device designed for almost any office setting.

- A noninterpretive 12-lead resting ECG that provides accurate ECG measurements
- Optional MEANS ECG interpretation software offers a second opinion
- High-resolution thermal printer generates standard full-sized reports and multiple printouts in the channel configuration you need
- Lead quality graphic saves valuable time and ensures accurate data capture by highlighting poor connections
- Standard SD card and slot for storage



CP 200™ with Optional Spirometry

Fully-featured with advanced options to help streamline workflow in your office. Same features as the CP 100 plus:

- Large colour LCD screen allows you to preview critical information on-screen easily
- Save time by using dedicated-function or "hot" keys to perform the most common functions without looking through menus
- Store up to 50 ECGs and 50 spirometry tests for later review, editing and interpretation of patient data
- Connect directly to the Welch Allyn CardioPerfect™ Workstation Software through plug-in cable interface
- Standard SD card and slot for storage
- Optional spirometry testing and optional MEANS interpretation software



For a full listing of model numbers for the CP 100 and CP 200, contact your local Welch Allyn representative.



CardioPerfect™ Workstation Software

Easy-to-use, intuitive software that is EMR ready

Access your patient data across the entire family of cardiopulmonary products with Welch Allyn CardioPerfect™ Workstation Software. This software manages data from these different diagnostic tests in the same way, allowing you to store all of your patient information in the same record. This permits you to retrieve and analyse information quickly, allowing you and your staff to be more efficient.

- Retrieve records with the touch of a key, and review and edit right on the screen
- Store thousands of records with ease
- Fax or e-mail reports directly for consults

RE-SW-ECG Welch Allyn CardioPerfect Workstation Software



ABPM 6100S

Accurate 24-hour ambulatory blood pressure monitoring with simple, one-button operation and powerful Windows®-based reporting software.

- Lightweight, compact and quiet for improved patient compliance
- Dynamic inflation automatically limits maximum cuff pressure for patient comfort
- Automatic cuff identification allows cuff size changes without reprogramming
- Two-year warranty on monitor
- Connects to Welch Allyn CardioPerfect™ Workstation Software for data storage and transfer of patient data to many leading EMRs

ABPM-6100S ABPM System with 6100 Recorder & Software
 ABPM-6100 ABPM 6100 Recorder Only with Accessories



MFI Solarc® Headlight

Our durable, comfortable, and lightweight surgical headlight delivers the bright, white light expected from a xenon system, but at a fraction of the cost.

- Welch Allyn's patented Solarc lamp provides white, xenon-quality light (5,500 °K) for more accurate colour and clearer tissue identification than 3,200 °K halogen systems
- The Solarc arc lamp has a median life of 550 hours
- Unique optical design provides at least 30% greater light intensity than leading halogen systems for excellent visualisation of the operative site
- Soft, flexible headband with a ratchet on the top and back for superior comfort and customised fit
- Fibre optic bundle is encased in three layers of protective materials to eliminate fibre breakage and reduce costs



49525* MFI Solarc Headlight System (Light Source, Fibre Optic Bundle, Headband/Luminaire)

*See International Conversion Codes chart on page 42 for local part numbers.



LumiView™ Portable Binocular Microscope

Unique 3-D optics for viewing into small cavities.

- Adapts the optical properties of a binocular microscope to converge user's vision into a magnified, stereoscopic 3-dimensional view
- Directs cool halogen light to the spot for clear 3-D image and accurate depth perception
- Simple to use, easy to carry and very affordable

20505H* LumiView Portable Binocular Microscope, Head Mount with Portable Battery Pack
20505S* LumiView Portable Binocular Microscope, Spectacle Mount with Portable Battery Pack



*See International Conversion Codes chart on page 43 for local part numbers.

Solid State Portable Headlight

Provides illumination precisely where it is needed, with cool, bright light that ensures comfort for both clinician and patient.

- Weighs just 113 grams—one of the most comfortable and lightweight headlights available
- Fits inside a shirt pocket and allows the user complete freedom of movement
- Supplies bright, white, shadow-free light for true tissue colour

46075* Portable Headlight with Direct Power Source and Charger
49642 Soft Terrycloth Headbands (box of 10)



Solid State Procedure Headlight

Targeted, well-defined illumination without the heat of traditional headlights.

- Weighs just 170 grams—extremely comfortable to wear for both simple and complex procedures
- Supplies bright, white, shadow-free light for true tissue colour
- Optional rechargeable battery pack makes this a completely portable, compact unit that allows the user freedom of movement

49025* Procedure Headlight with Direct Power Source
75265* Portable Power Source with Charger



*See International Conversion Codes chart on page 42 for local part numbers.



LS-150™ Examination Light

50 watts of bright, colour-corrected light for easier, faster general exams and specific tasks like suturing.

- Colour-corrected 50-watt lamp delivers significantly whiter light for better tissue diagnosis
- Luminaire stays cool to the touch, even during multiple exams
- Design allows clear view and one-hand positioning
- Optional caster base for portability

44505* LS-150 with Floor Stand
 44515* LS-150 with Wall Mount
 44350 Caster Base Accessory

LS-135™ Examination Light

High-quality, low-cost halogen illumination for the exam room.

- Long-lasting, 35-watt halogen lamp produces whiter, brighter light than conventional gooseneck units
- Dual-intensity control switch allows you to instantly adjust light output to match your exact requirements
- Compact base frees up valuable exam room floor space
- Optional caster base for portability

44305* LS-135 with Floor Stand
 44315* LS-135 with Wall Mount
 44350 Caster Base Accessory



44350



*See International Conversion Codes chart on page 42 for local part numbers.



LS-200™ Procedure Light

Brings light to all your procedures with high-quality, low-cost illumination.

- Superior manoeuvrability covers a wide range of positions without drifting or repositioning
- 61 cm working distance with 2,500 foot-candles light output and 3,200° K colour temperature enhances visualisation of the operative site and true tissue colour
- Three-lamp design ensures continuous, shadow-free illumination
- 18 cm spot size with feathered edge definition and 31 cm depth of field reduce eye strain

44205* LS-200 Procedure Light
 44250 Mobile Stand
 44210 Wall Mount Bracket



44250

*See International Conversion Codes chart on page 42 and 43 for local part numbers.



Exam Light III™

Flexible fibre optic lighting that lets you take brighter, whiter light anywhere without the heat.

- Mounts easily on a wall, stand, or examination table
- Durable fibre optic light pipe bends to almost any position and transmits cool illumination
- Small head leaves clear view of task areas
- Sealed focusing sleeve keeps optics free of dust
- Provides homogeneous spot and variable size
- Ideal for gynecological examinations and minor procedures

48725* Exam Light III™
 48850 Mobile Stand
 48859 Universal Table Mount



48850

48859



KleenSpec® Disposable Vaginal Specula and Illumination System

NEW
CORDLESS
VAGINAL SPECULA
AVAILABLE
SUMMER 2007

Conduct exams more completely and confidently with a vaginal speculum that transmits brighter, whiter halogen lighting to the speculum tip and directly onto the cervix.

- Molded-in light carrier projects halogen lighting to the speculum tip and directly onto the cervix for clearer viewing and diagnosis
- Illumination system includes 6 V halogen light handle, on/off switch, and transformer
- One-handed angulation and elevation provides multiple settings with positive-locking positions for easy operation
- Smooth, molded acrylic for maximum patient comfort
- Disposable for safety, economy and convenience
- Also available with preattached sheath to protect against cross-contamination



- 58000 KleenSpec Small Disposable Specula (case of 100)
- 58001 KleenSpec Medium Disposable Specula (case of 100)
- 58004 KleenSpec Large Disposable Specula (case of 80)
- 78815* Vaginal Illumination System with On/Off Switch and Transformer
- 78820 KleenSpec Illumination Storage System
- 78800 Vaginal Illumination System with On/Off Switch Only
- 73415* Transformer Only

Fibre Optic Anoscope/Sigmoidoscope Set

For convenience, safety, and optimal performance.

- Brilliant halogen light for true tissue colour
- Fibre optic light transmission gives unobstructed vision with 360° of cool, white light
- 45° bevel at distal end to facilitate instrumentation for anoscope

A complete system that allows you to achieve the perfect balance between patient comfort and optimal clinical performance.

- 36019 Fibre Optic Light Head
- 73500 3.5 V Battery Handle Adaptor
- 71910 3.5 V Lithium Ion Handle Only
- 73210 6 V Rectal Light Handle
- 73225* Rectal Light Handle with Transformer
- 73325* Transformer
- 30200 Insufflation Bulb
- 30210 Box of 10 Disposable Rectal Filters
- 53110 Box of 25 Disposable Anoscopes
- 53130-L Box of 25 Disposable Sigmoidoscopes

*See International Conversion Code chart on page 42 for local part numbers.

BATTERY-POWERED SYSTEM

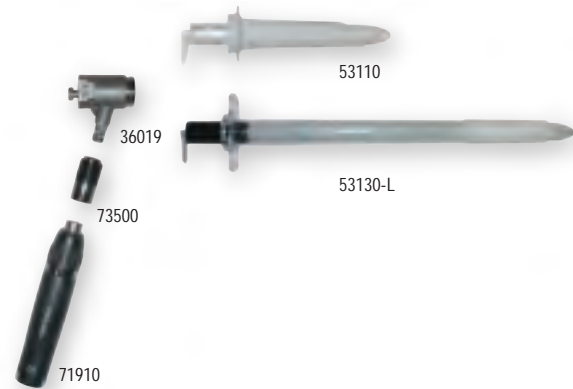

DIRECT-POWERED SYSTEM



Fibre Optic Laryngoscope Handles

Bright, white Halogen HPX™ illumination offers a clear, colour-corrected view.

- Patented HPX™ technology blends halogen and xenon gases under pressure to produce bright, white light for true tissue colour and consistent, long-lasting illumination
- Single lamp cartridge can be used across all sizes and handles
- Up to 40% lighter than our previous design, for increased responsiveness and manoeuvrability

Lightweight Battery-Powered Fibre Optic Handles

Model	Description
60813	Medium, uses two C-size batteries
60814	Penlight, uses two AA-size batteries
60815	Stubby, uses two AA-size batteries

Fibre Optic Laryngoscope Blades

- Removable, repolishable light pipes and free repolishing service help blades last longer
- Damaged light pathways can be repaired at a fraction of the cost of replacement blade
- Single-piece stainless steel construction ensures blade integrity

Macintosh Fibre Optic Blades

Model	Blade Size	Overall Length	Inside Base to Tip
69061	#1	89 mm	63 mm
69062	#2	108 mm	82 mm
69063	#3	126 mm	101 mm
69064	#4	160 mm	135 mm

English Macintosh Fibre Optic Blades

Model	Blade Size	Overall Length	Inside Base to Tip
69211	#1	95 mm	70 mm
69212	#2	116 mm	90 mm
69213	#3	135 mm	110 mm
69214	#4	156 mm	130 mm

Miller Fibre Optic Blades

Model	Blade Size	Overall Length	Inside Base to Tip
68065	#00	8 mm	37 mm
68060	#0	8 mm	53 mm
68061	#1	8 mm	79 mm
68062	#2	10 mm	132 mm
68063	#3	11 mm	172 mm
68064	#4	13 mm	182 mm

Consumables



A TRADITION OF QUALITY AND RELIABILITY



Welch Allyn—the First Name for Consumables

Welch Allyn consumable products are designed to maximise the performance of Welch Allyn instruments, and are manufactured to meet rigid conformance requirements. From otoscope specula to thermometry probe covers to lamps and batteries, Welch Allyn offers a full range of consumables for use with Welch Allyn products and devices.

For a full listing of Welch Allyn consumables, contact your local Welch Allyn representative or visit www.welchallyn.com.

WELCH ALLYN LAMPS:
BRIGHTER, WHITER LIGHT LONGER.
Lamp Output vs. Time

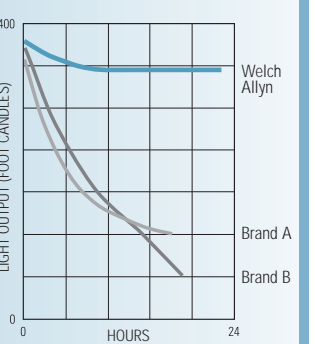

Hospital Consumables



Product Name	Part No.	Ref. Page	Product Affiliation
Disposable Ear Specula	52434-U	10	524 Series KleenSpec® Disposable Otoscope Specula, 4.25 mm, 850/bag, 10 bags/case
	52432-U	10	524 Series KleenSpec Disposable Otoscope Specula, 2.75 mm, 850/bag, 10 bags/case
	52401	6	524 Series Disposable Otoscope Specula Dispenser with Storage Compartment (case of 10)
Thermometry Probe Covers	05031-101	16, 17, 18	SureTemp® Disposable Probe Covers (case of 1,000 covers)
	05075-800	19	Braun Disposable Probe Covers for PRO 4000 (case of 5,000)
Paper Supplies	7052-25	17	Vital Signs Monitor Printer Paper, 1 case (6 rolls)
	94018-0000	30	Paper for CP 100/200 (200 sheets/pack, 5 packs/case)
Batteries	71960	7	Replacement Lithium Ion Battery
	72200	6	Replacement NiCad Rechargeable Battery (black) for Desk/Wall Charger Handle
Lamps	03000-U	9	Ophthalmoscope—11710
	03100-U	10	Otosopes—20000, 25020, 21700, 20200, 3.5 V Handle Adapter—73500 and Bivalve—26030
	03800-U	9	PanOptic™ Ophthalmoscopes—11810, 11820
	04200-U	35	Halogen Lamp for Exam Light II™—48600 and Exam Light III™—48700
	04430-U	34	35 W Halogen Lamp for LS-135 Exam Light—44300 and 44310
	04450-U	34	50 W Lamp for LS-150 Exam Light—44500 and 44510
	04900-U	9	Ophthalmoscopes—11720, 11730, 11735
	06000-U	37	Halogen HPX™ Lamp for Fibre Optic Laryngoscope Handles
	06400-U	35	20 W Lamp for LS-200™ Procedure Light—44200
	06500-U	10	MacroView™ Otoscope
	08800-U	36	4.6 V Halogen Lamp for Vag Spec Illumination System—78810
	07800-U	36	6 V Halogen Lamp for Vag Spec Illumination System—78000, Sigmoidoscope, Anoscope Light Handles
	08500-U	32	LumiView™ Replacement Lamp—20500, 20510
Disposable Sigmoidoscopes	53130-L	36	Individually Wrapped Disposable Sigmoidoscope Specula (19 mm x 25 cm) with Obturators (25/box)
Disposable Anoscopes	53110	36	Individually Wrapped Disposable Anoscope Specula (19 mm x 10 cm) with Obturators (25/box)
Vaginal Specula	58000	36	KleenSpec® 580 Series Disposable Vaginal Specula, Small (box of 25, case of 100)
	58001	36	KleenSpec® 580 Series Disposable Vaginal Specula, Medium (box of 25, case of 100)
	58004	36	KleenSpec® 580 Series Disposable Vaginal Specula, Large (box of 20, case of 80)
	58000S	36	KleenSpec® Small Disposable Specula with Attached Sheath (box of 20, case of 80)
	58001S	36	KleenSpec® Medium Disposable Specula with Attached Sheath (box of 20, case of 80)
	58004S	36	KleenSpec® Large Disposable Specula with Attached Sheath (box of 15, case of 60)
Miscellaneous	11870	9	PanOptic™ Patient Eye Cups (package of 5)
	52640	35	Disposable Sheaths for Exam Light II™ and Exam Light III™ (48600/48700)
	76700	6	3.5 V Locking Collars for Wall Transformers
	001855	26, 27	Defibrillator Pads, Adult, Box of 10
Electrodes	45008-0000	30	Resting Tab Electrodes (box of 1,000)

Replacement Bulbs and Batteries





Welch Allyn is both a major manufacturer of precision miniature and subminiature bulbs for medical applications, and exclusive supplier of bulbs for Welch Allyn diagnostic equipment. Only use Welch Allyn bulbs in Welch Allyn equipment. We strongly advise that only Welch Allyn bulbs are used as these have been purpose-designed to work with our equipment. Loss of warranty may result if damage is caused by other makes of bulbs.

Bulb No.	Bulb	Current Instruments	Bulb No.	Bulb	Current Instruments
01200-U		12500 BIO	07600-U		76600 Penlight (2.5 V)
02800-U		19090 (2.5 V)	07800-U		73210 Rectal 6 V Light Handle
02900-U		29090 Clinic Otoscope (2.5 V)	08200-U		18235 (Streak) Retinoscope (3.5 V)
03000-U		11710 Ophthalmoscope 12400 Strabismoscope 47300 Episcopes (3.5 V)	08300-U		18300 (Spot) Retinoscope (3.5 V)
03100-U		25020 27000 Various 20000 27050 Otophosopes 21700 28100 and ENT 20200 41100 Heads 20202 26030 73500 Rectal Adaptor (3.5 V)	08500-U		20505S LumiView and Flat 20505H Surface Magnifier 20515 20515H 20525S 20524H
03400-U		22821 Pocket Otoscope	08600-U		88005 89005
03500-U		23100P Compac Video Otophoscope	08800-U		78800 Vaginal Light Handle (4.6 V)
03600-U		60500 Expendable Laryngoscope (2.5 V)	09500-U		49525 MFI Headlight
03800-U		11810 PanOptic (HPX)			
03900-U		12821 Pocket Ophthalmoscope (2.5 V)			
04200-U		48725 Exam Light III			
04430-U		44305 LS-135 Light 44315			
04450-U		44505 LS-150 Light 44515			
04900-U		11720 Coaxial Ophthalmoscope			
06400-U		44205 LS-200 Light			
			Battery No.	Battery	Current Instruments
			72200		71670 NiCad Handle Desk Charger
			72240		74365 Portable BIO Power Source
			72300		71020-A NiCad Handle 71055-C NiCad Convertable Handle
			71960		71900 Lithium Ion Handle (3.5 V)
			72900		93695 MicroTym 2

International Conversion Codes

Product Description	Catalogue Code	Plug Style			
		 120 V USA/Japan	 220 V Europe	 240 V U.K.	 240 V Australia
767 Wall Transformer					
767 Wall Transformer with Handles Only	76715	76710	76712	76714	76716
767 Wall Transformer with Handles Only, plus Clock	76725	76720	76722	76724	76726
767 Wall Transformer with Clock, 11720 Coaxial Ophthalmoscope, 25020 Otoscope, 767 Wall Aneroid Sphygmomanometer, SureTemp Plus 690 Thermometer, KleenSpec Plus Otoscope Specula Dispenser, Wall-Mounting Board	76793-X	76793	76793-2	76793-4	76793-6
Universal Desk Charger Set					
Universal Desk Charger with 11810 PanOptic Ophthalmoscope, 23810 MacroView Oscope and 2 Lithium Ion Handles	71815-MPS	71811-MPS	71812-MPS	71814-MPS	71816-MPS
Universal Desk Charger with 11820 PanOptic Ophthalmoscope, 20000 Otoscope and 2 NiCad Handles	71835-P	71830-P	71832-P	71834-P	71836-P
Universal Desk Charger with 11720 Coaxial Ophthalmoscope, 20000 Otoscope and 2 Lithium Ion Handles	71825-SM	N/A	71822-SM	71824-SM	71826-SM
Universal Desk Charger with 11720 Coaxial Ophthalmoscope, 25020 Otoscope and NiCad Handles	71745	71641	71742	71744	71746
Universal Desk Charger Only	71145	71140	71142	71144	71146
3.5 V Lithium Ion Rechargeable Handle					
Lithium Ion Handle with Pod and Charger	71905	71907	71902	71904	71906
Exam Light III™					
Exam Light III	48725	48700	48722	48724	48726
LS-150™ Examination Light					
LS-150 with Floor Stand	44505	44500	44502	44504	44506
LS-150 with Wall Mount	44515	44510	44512	44514	44516
LS-135™ Examination Light					
LS-135 with Floor Stand	44305	44300	44302	44304	44306
LS-135 with Wall Mount	44315	44310	44312	44314	44316
Portable Solid State Headlight					
Portable Solid State Headlight	46075	46070	46072	46074	46076
Portable Power Source with Charger	75265	75260	75262	75264	75266
Procedure Solid State Headlight					
Procedure Solid State Headlight	49025	49020	49022	49024	49026
Anoscope/Sigmoidoscope Set					
Rectal Light Handle with Transformer	73225	73220	73222	73224	73226
Transformer	73325	73305	73322	73324	73326
MFI Solarc® Headlight					
MFI Solarc Headlight, Complete System	49525	49520	49522	49524	49526

International Conversion Codes (continued)

Product Description	Catalogue Code	Plug Style			
		 120 V USA/Japan	 220 V Europe	 240 V U.K.	 240 V Australia
LumiView™ Portable Binocular Microscope					
Portable Binocular Microscope, Head Mount with Portable Battery Pack	20505H	20500H	20502H	20504H	20506H
Portable Binocular Microscope, Spectacle Mount with Portable Battery Pack	20505S	20500S	20502S	20504S	20506S
Flat Surface Magnifier, Head Mount with Portable Battery Pack	20525H	20520H	20522H	20524H	20526H
Flat Surface Magnifier, Spectacle Mount with Portable Battery Pack	20525S	20520S	20522S	20524S	20526S
Spot Vital Signs®*					
NIBP only (Pulse Rate & MAP)		4200B-E1	4200B-E2	4200B-E4	4200B-E6
NIBP/Temperature		420TB-E1	420TB-E2	420TB-E4	420TB-E6
NIBP/Neelcor Pulse Oximetry		42N0B-E1	42N0B-E2	42N0B-E4	42N0B-E6
NIBP/Neelcor Pulse Oximetry/Temperature		42NTB-E1	42NTB-E2	42NTB-E4	42NTB-E6
NIBP/Masimo Pulse Oximetry		42M0B-E1	42M0B-E2	42M0B-E4	42M0B-E6
NIBP/Masimo Pulse Oximetry/Temperature		42MTB-E1	42MTB-E2	42MTB-E4	42MTB-E6
<i>*Please note, the letter 'E' in the code suffix above signifies English language. If Chinese language is required, please replace the 'E' with a 'C'.</i>					
Spot Vital Signs LXi*					
NIBP/SureTemp Plus Thermometry		450T0-E1	450T0-E2	450T0-E4	450T0-E6
NIBP/Braun ThermoScan PRO 4000 Thermometry		450E0-E1	450E0-E2	450E0-E4	450E0-E6
NIBP/Neelcor Pulse Oximetry/SureTemp Plus Thermometry		45NT0-E1	45NT0-E2	45NT0-E4	45NT0-E6
NIBP/Masimo Pulse Oximetry/SureTemp Plus Thermometry		45MT0-E1	45MT0-E2	45MT0-E4	45MT0-E6
NIBP/Neelcor Pulse Oximetry/Braun ThermoScan PRO 4000 Thermometry		45NE0-E1	45NE0-E2	45NE0-E4	45NE0-E6
NIBP/Masimo Pulse Oximetry/Braun ThermoScan PRO 4000 Thermometry		45ME0-E1	45ME0-E2	45ME0-E4	45ME0-E6
<i>*Please note, the letter 'E' in the code suffix above signifies English language. If Chinese language is required, please replace the 'E' with a 'C'.</i>					
Vital Signs Monitor 300 Series*					
NIBP only (includes Pulse Rate & MAP)		53000-E1	53000-E2	53000-E4	53000-E6
NIBP/Printer		5300P-E1	5300P-E2	5300P-E4	5300P-E6
NIBP/Temperature		530T0-E1	530T0-E2	530T0-E4	530T0-E6
NIBP/Temperature/Printer		530TP-E1	530TP-E2	530TP-E4	530TP-E6
NIBP/Neelcor Pulse Oximetry		53N00-E1	53N00-E2	53N00-E4	53N00-E6
NIBP/Neelcor Pulse Oximetry/Printer		53NOP-E1	53NOP-E2	53NOP-E4	53NOP-E6
NIBP/Temperature/Neelcor Pulse Oximetry		53NT0-E1	53NT0-E2	53NT0-E4	53NT0-E6
NIBP/Temperature/Neelcor Pulse Oximetry/Printer		53NTP-E1	53NTP-E2	53NTP-E4	53NTP-E6
NIBP/Masimo Pulse Oximetry		53S00-E1	53S00-E2	53S00-E4	53S00-E6
NIBP/Masimo Pulse Oximetry/Printer		53SOP-E1	53SOP-E2	53SOP-E4	53SOP-E6
NIBP/Temperature/Masimo Pulse Oximetry		53ST0-E1	53ST0-E2	53ST0-E4	53ST0-E6
NIBP/Temperature/Masimo Pulse Oximetry/Printer		53STP-E1	53STP-E2	53STP-E4	53STP-E6
<i>*Please note, the letter 'E' in the code suffix above signifies English language. If Chinese language is required, please replace the 'E' with a 'C'.</i>					
LS-200™ Procedure Light					
LS-200 Procedure Light	44205	44200	44202	44204	44206
KleenSpec® Illumination System					
KleenSpec Illumination System with On/Off Switch	78815	78810	78812	78814	78816
Transformer Only	73415	73410	73412	73414	73416